

# User's Manual

## FreeZone® 6, 12 and 18 Liter Freeze Dry Systems

### Models

7753020	7753522	7754030	7755030	7934020	7960030
7753021	7753524	7754031	7755031	7934021	7960031
7753022	7753532	7754032	7755032	7934022	7960032
7753024	7753534	7754034	7755034	7934024	7960034
7753026	7753542	7754036	7755036	7934026	7960036
7753027	7753544	7754037	7755037	7934027	7960037
7753030		7754040	7755040	7934030	7960040
7753031		7754041	7755041	7934031	7960041
7753032		7754042	7755042	7934032	7960042
7753034		7754044	7755044	7934034	7960044
7753036		7754046	7755046	7934036	7960046
7753037		7754047	7755047	7934037	7960047
7753040				7934040	
7753041				7934041	
7753042				7934042	
7753044				7934044	
7753046				7934046	
7753047				7934047	



*Protecting your  
laboratory environment*

**LABCONCO®**



Labconco's Mascot,  
Labby the LABster

FreeZone® is a registered trademark of Labconco Corporation.

## **Warranty**

Labconco provides a warranty on all parts and factory workmanship. The warranty includes areas of defective material and workmanship, provided such defect results from normal and proper use of the equipment.

The warranty for all Labconco products will expire one year from date of installation or two years from date of shipment from Labconco, whichever is sooner, except the following:

- Purifier® Delta® Series Biological Safety Cabinets and PuriCare® Lab Animal Products carry a three-year warranty from date of installation or four years from date of shipment from Labconco, whichever is sooner.
- Steamscrubber & Flaskscrubber Glassware Washers carry a two year warranty from date of installation or three years from date of shipment from Labconco, whichever is sooner.
- Carts carry a lifetime warranty.
- Glassware is not warranted from breakage when dropped or mishandled.

This limited warranty covers parts and labor, but not transportation and insurance charges. In the event of a warranty claim, contact Labconco Corporation or the dealer who sold you the product. If the cause is determined to be a manufacturing fault, the dealer or Labconco Corporation will repair or replace all defective parts to restore the unit to operation. Under no circumstances shall Labconco Corporation be liable for indirect, consequential, or special damages of any kind. This statement may be altered by a specific published amendment. No individual has authorization to alter the provisions of this warranty policy or its amendments. Lamps and filters are not covered by this warranty. Damage due to corrosion or accidental breakage is also not covered.

## **Limitation of Liability**

The disposal and/or emission of substances used in connection with this equipment may be governed by various federal, state, or local regulations. All users of this equipment are required to become familiar with any regulations that apply in the user's area concerning the dumping of waste materials in or upon water, land, or air and to comply with such regulations. Labconco Corporation is held harmless with respect to user's compliance with such regulations.

For more information, please contact us:

[ExpotechUSA](#)  
[10700 Rockley Road](#)  
[Houston, Texas 77099](#)  
[USA](#)

[281-496-0900 \[voice\]](#)

[281-496-0400 \[fax\]](#)

E-mail: [sales@expotechusa.com](mailto:sales@expotechusa.com)

Website: [www.ExpotechUSA.com](http://www.ExpotechUSA.com)

---

# TABLE OF CONTENTS

<b>CHAPTER 1: INTRODUCTION</b>	1
Freeze Dry Process	1
Freeze Dry Rates	2
Freeze Dry Capacity	3
Samples Containing Volatile Substances	4
About This Manual	4
Typographical Conventions	6
<b>CHAPTER 2: PREREQUISITES</b>	7
Electrical Requirements	7
Location Requirements	8
Vacuum Pump Requirements	8
Chamber or Manifold Requirements	8
<b>CHAPTER 3: GETTING STARTED</b>	9
Unpacking Your Freeze Dryer	9
Freeze Dryer Components	10
Setting Up Your Freeze Dryer	12
Vacuum Pump Connection	13
Electrical Connection	14
Drying Chamber or Drying Manifold Installation	14
Chemical Resistance of Freeze Dryer Components	14
Solvent Safety Precautions	16
<b>CHAPTER 4: USING YOUR FREEZE DRYER</b>	18
Freeze Dryer Controls	19
Operation Checklist	21
Vacuum Pump Ballast Setting	21
Purge Valve	21
Operating the Freeze Dryer	22
Set-Up	22
Baffle	25
Automatic Start-Up	25
Automatic Start Up with Purge Valve	25
Manual Start-Up	26
Manual Start-Up with Purge Valve	26

Setting the Operating Vacuum Level	27
Pre-Freezing Samples	27
Adding Sample	28
Shut Down	29
Defrosting	29
Operating the Shell Freezer	30
Operating the Vacuum Drying Chamber	31
Alarms	32
Power Failure	32
Line Voltage Out of Range	33
Temperature Out of Range	33
Service Vacuum Pump	34
Moisture in Collector	34
<b>CHAPTER 5: MAINTAINING YOUR FREEZE DRYER</b>	<b>35</b>
<b>CHAPTER 6: USING THE RS232 RECEPTACLE</b>	<b>37</b>
Computer Connection for Computer Interface	37
<b>CHAPTER 7: TROUBLESHOOTING</b>	<b>42</b>
Vacuum Pump	42
Gaskets, Tubing, Connections, Sample Valves	43
System Components & Collection Chamber Isolation	45
Refrigeration Module Operation	48
<b>CHAPTER 8: MODIFYING YOUR FREEZE DRYER DISPLAY</b>	<b>49</b>
Temperature & Vacuum Display	49
Line Voltage Alarm Points	49
Moisture Sensor Alarm	50
Modifying the Display	50
<b>APPENDIX A: FREEZE DRYER COMPONENTS</b>	<b>54</b>
<b>APPENDIX B: FREEZE DRYER DIMENSIONS</b>	<b>59</b>
<b>APPENDIX C: FREEZE DRYER SPECIFICATIONS</b>	<b>60</b>
Electrical Specifications	60
Environmental Conditions	63
Wiring Diagrams	64
<b>APPENDIX D: FREEZE DRYER ACCESSORIES</b>	<b>67</b>
<b>DECLARATION OF CONFORMITY</b>	<b>76</b>

---

# CHAPTER 1

## INTRODUCTION

Congratulations on your purchase of a Labconco FreeZone® Freeze Dry System, which is designed for laboratory lyophilization procedures. The refrigerant used in the refrigeration system is CFC-free so it will not endanger the environment. The unit is easy to install and maintain. Proper care and maintenance of this product will result in many years of dependable service.

### Freeze Dry Process

Freeze drying is an important process in sample preparation and for the preservation and storage of biologicals, pharmaceuticals and foods. Of the various methods of dehydration, freeze drying (lyophilization) is especially suited for substances that are heat sensitive. Other than food processing (e.g., coffee, whole dinners), freeze drying has been extensively used in the development of pharmaceuticals (e.g., antibiotics) and preservation of biologicals (e.g., proteins, plasma, viruses and cell lines). The nondestructive nature of this process has been demonstrated by the retention of viability in freeze dried viruses and microorganisms.

Freeze drying is a process whereby water or other solvent is removed from frozen material by converting the frozen water directly into vapor without the intermediate formation of liquid water. The basis for this sublimation process involves the absorption of heat by the frozen sample in order to vaporize the ice; the use of a vacuum pump to enhance the removal of water vapor from the surface of the sample; the transfer of water vapor to a collector; and the removal of heat by the collector in order to condense the water vapor. In essence, the freeze dry process is a balance between the heat absorbed by the sample to vaporize the

ice and the heat removed from the collector to convert the water vapor into ice.

## Freeze Dry Rates

The efficiency of the freeze drying process is dependent upon the surface area and the thickness of the sample, the collector temperature and vacuum obtained, the eutectic point and solute concentration of the sample. It is important to remember these factors when trying to obtain efficient utilization of your freeze dry system. A listing of selected materials and their approximate drying times are shown in Table 1 for your reference.

**Table 1**

SAFE TEMPERATURE AND DRYING TIMES FOR SELECTED MATERIALS			
Material 10mm Thick	Safe Temperature °C	Collector Temperature °C	Hours (Approx.)
Milk	-5	-40	10
Urea	-7	-40	10
Blood Plasma	-10 to -25	-40	16
Serum	-25	-40	18
Vaccinia	-30 to -40	-50	22
Influenza Vaccine	-30	-50	24
Human Tissue	-30 to -40	-50	48
Vegetable Tissue	-50	-80	60

\*Total sample quantities are contingent on various freeze dryer capacities.

Up to the point of overloading the system, the greater the surface area of the sample, the faster the rate of freeze drying. By contrast, for a given surface area, the thicker the sample the slower the rate of freeze drying. This is based on the fact that the heat of sublimation is usually absorbed on one side of the frozen sample and must travel through the frozen layer to vaporize water at the other surface. In addition, as the sample is freeze dried, the water vapor must travel through the layer of dried material. The thicker the sample, the greater the chance that the dried layer may collapse which would cause an additional decrease in the rate of freeze drying.

The surface area and thickness of the sample can usually be ignored when each sample contains only a few milliliters. However, for larger volumes, the samples should be shell frozen to maximize the surface area and minimize the thickness of the

sample. The volume of the freeze dry flask should be two to three times the volume of the sample.

In order for lyophilization to occur, ice must be removed from the frozen sample via sublimation. This is accomplished by the collector and the vacuum pump. The collector, which should be at least 15 to 20°C colder than the eutectic temperature (melting temperature) of the sample, traps vapor as ice. Since the vapor pressure at the collector is lower than that of the sample, the flow of water vapor is from the sample to the collector. Since this vapor diffusion process occurs very slowly under normal atmospheric conditions, a good vacuum is essential to maintain an efficient rate. In many applications, the maintenance of a vacuum of 0.133 mBar or less is recommended.

The rate of freeze drying is directly proportional to the vapor pressure and the vapor pressure is dependent upon both eutectic temperature and solute concentration of the sample. For example, a solution of sodium chloride and water would freeze dry at a slower rate than pure water. The eutectic temperature of a sodium chloride solution is about -21°C and at this temperature the vapor pressure is about 1/16 that of water at 0°C. Although the eutectic temperature is not dependent upon the concentration of sodium chloride, the vapor pressure of the water would decrease as the concentration of sodium chloride increased. This is due to the fact that as the solute concentration increases, less of the surface area of the frozen sample is occupied by water. In general, most solutions or biological samples will have a eutectic temperature of -10° to -25°C. However, if the sample contains a simple sugar such as glucose or if the sample is animal or plant tissue, the eutectic temperature may be as low as -30° to -50°C.

## Freeze Dry Capacity

The volume of a sample that can be freeze dried at one time is related to factors discussed previously and the size and design of the freeze dry system. With any given instrument, the capacity is based on the surface area of the sample, the eutectic temperature and concentration of the sample and the rate and amount of heat transferred to the frozen sample. Of these factors, the eutectic temperature is the most important factor in determining the amount of sample that can be freeze dried at one time, particularly when flasks are used. This is because as the eutectic temperature decreases, the vapor pressure decreases but the rate of heat absorption by the sample does not change. This tends to promote melting of the sample, which leads to a marked increase in vapor



pressure and ultimately overloads the collector and vacuum pump. Samples that have eutectic temperatures of  $-20^{\circ}\text{C}$  or lower should be placed on the freeze dry system one flask at a time so that the vacuum in the system may recover before adding another sample to the system. If the vacuum does not recover, the capacity of the freeze dry system has been exceeded and the sample should be removed.

If there is a problem with a particular type of sample melting when placed on the freeze dry system, dilution of the sample with more water or providing some insulation around the flask to decrease the rate of heat absorption by the sample may help. If the eutectic temperature of the sample is  $-40$  to  $-60^{\circ}\text{C}$ , the freeze dry system selected for use must be equipped with cascade type refrigeration so that the collector temperature can be cooled to below  $-75^{\circ}\text{C}$ , or a dry ice/solvent trap may be used between the collector and the vacuum pump.

## **Samples Containing Volatile Substances**

In certain cases the solvent in a sample to be freeze dried may contain volatile components such as acetonitrile, methanol, acetic acid, formic acid or pyridine. In addition to these substances having an effect on the eutectic temperature, they may increase the vapor pressure at the surface of the sample. Also, compared to water, they will require the absorption of less heat for sublimation to occur. Hence, samples that contain volatile substances will have a greater tendency to melt, particularly when placed in flasks or exposed to room temperature. If a sample containing a volatile substance tends to melt when placed on a freeze dry system, dilution of the sample with more water will help keep the sample frozen. For example, a 0.2M solution of acetic acid is much easier to freeze dry than a 0.5M solution.

## **About This Manual**

This manual is designed to help you learn how to install, use, and maintain your Freeze Dryer. Instructions for performing routine maintenance and making minor modifications to your Freeze Dryer are also included.

*Chapter 1: Introduction* provides a brief overview of the Freeze Dryer, explains the organization of the manual, and defines the typographical conventions used in the manual.

*Chapter 2: Prerequisites* explains what you need to do to prepare your site before you install your Freeze Dryer. Electrical requirements are discussed.

*Chapter 3: Getting Started* contains the information you need to properly unpack, inspect and install your Freeze Dryer.

*Chapter 4: Using Your Freeze Dryer* discusses the basic operation of your Freeze Dryer. Information on how to attach samples and run the Freeze Dryer is included.

*Chapter 5: Maintaining Your Freeze Dryer* explains how to perform routine maintenance on your Freeze Dryer.

*Chapter 6: Using the RS232 Receptacle* describes how to connect a computer for monitoring the operation.

*Chapter 7: Troubleshooting* contains a table of problems you may encounter while using your Freeze Dryer, including the probable causes of the problems, and suggested corrective actions.

*Chapter 8: Modifying Your Freeze Dryer Display* describes how to calibrate the vacuum display restore factory settings.

*Appendix A: Freeze Dryer Components* contains labeled diagrams of the components of the Freeze Dryer.

*Appendix B: Freeze Dryer Dimensions* contains comprehensive diagrams showing the dimensions for the Freeze Dryer.

*Appendix C: Freeze Dryer Specifications* contains product specifications. A wiring diagram for the Freeze Dryer is also included.

*Appendix D: Freeze Dryer Accessories* lists the part numbers and descriptions of all of the accessories available for your Freeze Dryer.

## Typographical Conventions

Recognizing the following typographical conventions will help you understand and use this manual:

- Book, chapter, and section titles are shown in italic type (e.g., *Chapter 3: Getting Started*).
- Steps required to perform a task are presented in a numbered format.
- Comments located in the margins provide suggestions, reminders, and references.
- Critical information is presented in boldface type in paragraphs that are preceded by the exclamation icon. Failure to comply with the information following an exclamation icon may result in injury to the user or permanent damage to your Freeze Dryer.
- Important information is presented in capitalized type in paragraphs that are preceded by the pointer icon. It is imperative that the information contained in these paragraphs be thoroughly read and understood by the user.



---

# CHAPTER 2

## PREREQUISITES

Before you install your Freeze Dryer, you need to prepare your site for installation. Carefully examine the location where you intend to install your Freeze Dryer. You must be certain that the area is level and of solid construction. An electrical source must be located near the installation site.

Carefully read this chapter to learn:

- the electrical supply requirements.
- the vacuum pump requirements.

Refer to *Appendix C: Freeze Dryer Specifications* for complete Freeze Dryer electrical and environmental conditions, specifications and requirements.

### Electrical Requirements

The Freeze Dryer requires a dedicated electrical outlet. This outlet requires a 20 Amp circuit breaker or fuse for models rated at 115V (60 Hz). An outlet equipped with a 15 Amp circuit breaker or fuse is required for models rated at 230V (50/60 Hz). The power cord on 115V models is equipped with a 20 Amp NEMA 5-20P plug. The power cord on 230V models is equipped with a NEMA 6-20P plug. If this does not match with the available receptacle, remove this plug and replace it with an approved plug of the suitable style.

## Location Requirements

The Freeze Dryer should be located in an area that provides an unobstructed flow of air around the cabinet. This air cools the refrigeration system. The refrigeration system draws air in through the sides and exhausts it through the rear. A minimum of 3" must be allowed between the rear and both sides of the Freeze Dryer and adjacent wall surfaces. Restriction of airflow during operation could adversely affect performance.

Refer to *Appendix C: Freeze Dryer Specifications* for dimensional drawings of the Freeze Dryer.

## Vacuum Pump Requirements

A vacuum pump must be provided by the user. A vacuum pump with a displacement of 144 liters per minute and 0.0002 mBar ultimate pressure is adequate for most samples. The inlet fitting on the vacuum pump must be suitable for 3/4" ID vacuum hose, which is provided. It is recommended that the vacuum pump is equipped with an exhaust filter to minimize oil mist exhausting from the vacuum pump. The operating vacuum level may be set on the Freeze Dryer. The higher the pressure is set, the more likely it is that oil mist will be exhausted.

Vacuum pumps used with 115V models should be equipped with an 115V, 15 Amp NEMA 5-15P plug. Vacuum pumps used with 230V models should be equipped with a reverse IEC plug. This plug is included with 230V models. This will allow the vacuum pump to be plugged into the receptacle on the back panel of the freeze dryer. See *Appendix D: Freeze Dryer Accessories* for vacuum pumps available from Labconco.

## Chamber or Manifold Requirements

A freeze drying chamber is not included and must be purchased separately. These allow samples to be attached to the Freeze Dryer. See *Appendix D: Freeze Dryer Accessories* for available chambers and manifolds.

---

# CHAPTER 3

## GETTING STARTED

Now that the site for your Freeze Dryer is properly prepared, you are ready to unpack, inspect, install and test your Freeze Dryer. Read this chapter to learn how to:

- unpack and move your Freeze Dryer.
- set up your Freeze Dryer.
- connect the electrical supply source to your Freeze Dryer.
- properly exhaust your Freeze Dryer.
- safely use solvents with your Freeze Dryer.



**The FreeZone Freeze Dry System may weigh as much as 330 lbs. (150 kg) depending upon the model. If you must lift the Freeze Dryer manually, use at least two (2) persons and follow safe lifting guidelines.**

### Unpacking Your Freeze Dryer

Carefully unpack your Freeze Dryer and inspect it for damage that may have occurred in transit. If your Freeze Dryer is damaged, notify the delivery carrier immediately and retain the entire shipment intact for inspection by the carrier.



**DO NOT RETURN GOODS WITHOUT THE PRIOR AUTHORIZATION OF LABCONCO. UNAUTHORIZED RETURNS WILL NOT BE ACCEPTED.**

*The United States Interstate Commerce Commission rules require that claims be filed with the delivery carrier within fifteen (15) days of delivery.*

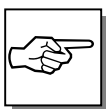

IF YOUR FREEZE DRYER WAS DAMAGED IN TRANSIT, YOU MUST FILE A CLAIM DIRECTLY WITH THE FREIGHT CARRIER. LABCONCO CORPORATION AND ITS DEALERS ARE NOT RESPONSIBLE FOR SHIPPING DAMAGE.

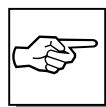

DO NOT DISCARD THE CARTON OR PACKING MATERIAL FOR YOUR FREEZE DRYER UNTIL YOU HAVE CHECKED ALL OF THE COMPONENTS AND INSTALLED AND TESTED THE FREEZE DRYER.

## Freeze Dryer Components

Locate the model of Freeze Dryer you received in the following table. Verify that the components listed are present and undamaged.

Catalog Numbers 6, 12 and 18 Liter Console Models							
Catalog Number	Description	Volts	Hz	Teflon Coated Chamber	Purge Valve	Drying Chamber	Shell Freezer
7753020	6 Liter Freeze Dryer	115	60				
7753021	6 Liter Freeze Dryer	115	60	x			
7753022	6 Liter Freeze Dryer	115	60		x		
7753024	6 Liter Freeze Dryer	115	60	x	x		
7753026	6 Liter Freeze Dryer	115	60		x	x	
7753027	6 Liter Freeze Dryer	115	60	x	x	x	
7753030	6 Liter Freeze Dryer	230	50				
7753031	6 Liter Freeze Dryer	230	50	x			
7753032	6 Liter Freeze Dryer	230	50		x		
7753034	6 Liter Freeze Dryer	230	50	x	x		
7753036	6 Liter Freeze Dryer	230	50		x	x	
7753037	6 Liter Freeze Dryer	230	50	x	x	x	
7753040	6 Liter Freeze Dryer	230	60				
7753041	6 Liter Freeze Dryer	230	60	x			
7753042	6 Liter Freeze Dryer	230	60		x		
7753044	6 Liter Freeze Dryer	230	60	x	x		
7753046	6 Liter Freeze Dryer	230	60		x	x	
7753047	6 Liter Freeze Dryer	230	60		x	x	
7753522	6 Liter Freeze Dryer	115	60		x		x
7753524	6 Liter Freeze Dryer	115	60	x	x		x
7753532	6 Liter Freeze Dryer	230	50		x		x
7753534	6 Liter Freeze Dryer	230	50	x	x		x
7753542	6 Liter Freeze Dryer	230	60		x		x
7753544	6 Liter Freeze Dryer	230	60	x	x		x

Catalog Numbers 6, 12 and 18 Liter Console Models							
Catalog Number	Description	Volts	Hz	Teflon Coated Chamber	Purge Valve	Drying Chamber	Shell Freezer
7934020	6 Liter Cascade Freeze Dryer	115	60				
7934021	6 Liter Cascade Freeze Dryer	115	60	x			
7934022	6 Liter Cascade Freeze Dryer	115	60		x		
7934024	6 Liter Cascade Freeze Dryer	115	60	x	x		
7934026	6 Liter Cascade Freeze Dryer	115	60		x	x	
7934027	6 Liter Cascade Freeze Dryer	115	60	x	x	x	
7934030	6 Liter Cascade Freeze Dryer	230	50				
7934031	6 Liter Cascade Freeze Dryer	230	50	x			
7934032	6 Liter Cascade Freeze Dryer	230	50		x		
7934034	6 Liter Cascade Freeze Dryer	230	50	x	x		
7934036	6 Liter Cascade Freeze Dryer	230	50		x	x	
7934037	6 Liter Cascade Freeze Dryer	230	50	x	x	x	
7934040	6 Liter Cascade Freeze Dryer	230	60				
7934041	6 Liter Cascade Freeze Dryer	230	60	x			
7934042	6 Liter Cascade Freeze Dryer	230	60		x		
7934044	6 Liter Cascade Freeze Dryer	230	60	x	x		
7934046	6 Liter Cascade Freeze Dryer	230	60		x	x	
7934047	6 Liter Cascade Freeze Dryer	230	60	x	x	x	
7754030	12 Liter Freeze Dryer	230	50				
7754031	12 Liter Freeze Dryer	230	50	x			
7754032	12 Liter Freeze Dryer	230	50		x		
7754034	12 Liter Freeze Dryer	230	50	x	x		
7754036	12 Liter Freeze Dryer	230	50		x	x	
7754037	12 Liter Freeze Dryer	230	50	x	x	x	
7754040	12 Liter Freeze Dryer	230	60				
7754041	12 Liter Freeze Dryer	230	60	x			
7754042	12 Liter Freeze Dryer	230	60		x		
7754044	12 Liter Freeze Dryer	230	60	x	x		
7754046	12 Liter Freeze Dryer	230	60		x	x	
7754047	12 Liter Freeze Dryer	230	60	x	x	x	
7960030	12 Liter Cascade Freeze Dryer	230	50				
7960031	12 Liter Cascade Freeze Dryer	230	50	x			
7960032	12 Liter Cascade Freeze Dryer	230	50		x		
7960034	12 Liter Cascade Freeze Dryer	230	50	x	x		
7960036	12 Liter Cascade Freeze Dryer	230	50		x	x	
7960037	12 Liter Cascade Freeze Dryer	230	50	x	x	x	
7960040	12 Liter Cascade Freeze Dryer	230	60				
7960041	12 Liter Cascade Freeze Dryer	230	60	x			
7960042	12 Liter Cascade Freeze Dryer	230	60		x		
7960044	12 Liter Cascade Freeze Dryer	230	60	x	x		
7960046	12 Liter Cascade Freeze Dryer	230	60		x	x	
7960047	12 Liter Cascade Freeze Dryer	230	60	x	x	x	



Catalog Numbers 6, 12 and 18 Liter Console Models							
Catalog Number	Description	Volts	Hz	Teflon Coated Chamber	Purge Valve	Drying Chamber	Shell Freezer
7755030	18 Liter Freeze Dryer	230	50				
7755031	18 Liter Freeze Dryer	230	50	x			
7755032	18 Liter Freeze Dryer	230	50		x		
7755034	18 Liter Freeze Dryer	230	50	x	x		
7755036	18 Liter Freeze Dryer	230	50		x	x	
7755037	18 Liter Freeze Dryer	230	50	x	x	x	
7755040	18 Liter Freeze Dryer	230	60				
7755041	18 Liter Freeze Dryer	230	60	x			
7755042	18 Liter Freeze Dryer	230	60		x		
7755044	18 Liter Freeze Dryer	230	60	x	x		
7755046	18 Liter Freeze Dryer	230	60		x	x	
7755047	18 Liter Freeze Dryer	230	60	x	x	x	

Plus the Following:	
Part #	Component Description
7403400	User's Manual
1336400	Power Cord – 115V or
1342100	Power Cord – 230V
1291000	Plug (230V models only)
7646000	Vacuum Hose
1967600	Hose Clamps (2)
7532900	Collector Chamber Lid
7690800	Collector Chamber Lid Gasket
7408300	Drying Chamber Lid (if so equipped)
7408400	Drying Chamber and Shell Freezer Lid Gasket (if so equipped)
7403100	Shell Freezer Lid (if so equipped)
1429900	Stopper (with Drying Chamber only)
7390702	Baffle (6L Cascade only)
7390701	Baffle (12L Cascade only)
7390700	Baffle (18L Only)

If you did not receive one or more of the components listed for your Freeze Dryer, or if any of the components are damaged, contact Labconco Corporation immediately for further instructions.

## Setting Up Your Freeze Dryer

After you verify receipt of the proper components, move your Freeze Dryer to the location where you want to install it. Then, follow the steps listed below.

## Vacuum Pump Connection

A vacuum pump as described in *Chapter 2: Prerequisites* is required to operate your Freeze Dry System properly. The Freeze Dryer is equipped with a 3/4" ID, heavy wall, vacuum hose for connecting the collector chamber to the vacuum pump.



**Make certain that the oil in the vacuum pump is at the proper level.**

Remove the front stainless steel panel or lower rear panel from the Freeze Dryer. The front panel is removed by placing a flat blade screw driver into the rectangular hole in the center of the kick panel. Pivot the handle downward to disengage the latch and simultaneously pull the lower panel forward.

Place the vacuum pump inside the cabinet. Connect the vacuum pump power cord to the receptacle on the back of the cabinet labeled “vacuum pump.” Models rated for use on 230V have a reverse IEC connector for attaching the vacuum pump power cord. A plug is supplied that can be installed on the vacuum pump power cord if necessary. If the vacuum pump has an off/on switch, turn the switch on. The vacuum pump will be controlled by the Freeze Dryer. Connect the vacuum pump inlet port to the vacuum tube inside the cabinet near the front with the vacuum hose and clamps provided. If necessary, cut the hose to proper length to allow for gentle bends without kinks.

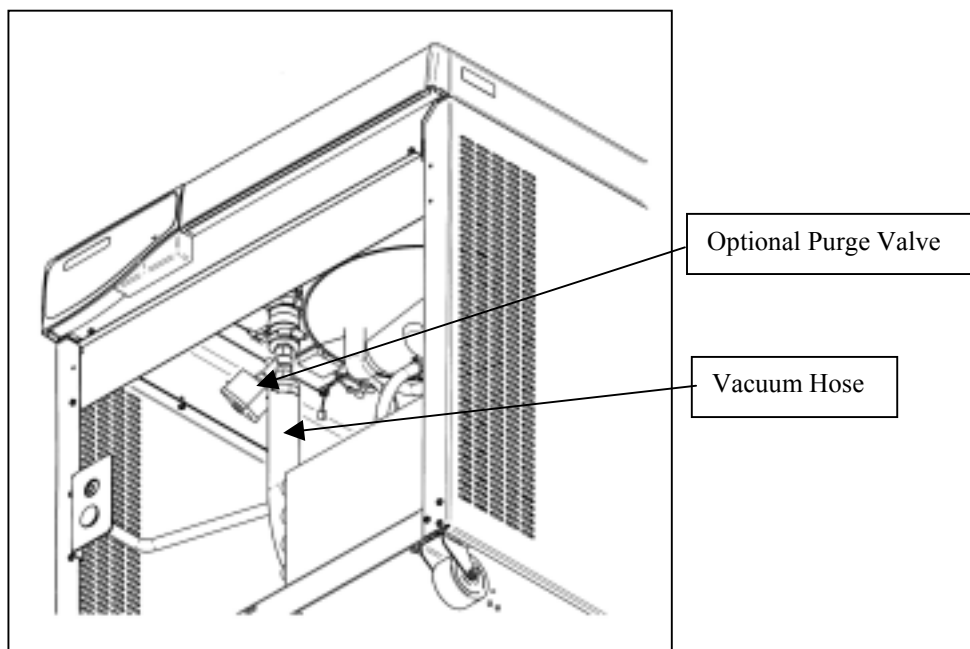

The lower front panel is installed by first sliding the top edge under the lip on the plastic control panel. Pivot the bottom inward and push until the latch is secure.

## **Electrical Connection**

Plug the power cord into the receptacle on the back of the Freeze Dryer and plug the other end into a suitable power receptacle.

## **Drying Chamber or Drying Manifold Installation**

The drying chamber or drying manifold, purchased separately, may be positioned directly above the 3-inch port on the top of the Freeze Dryer. Follow the instructions supplied with the selected accessory.

## **Chemical Resistance of Freeze Dryer Components**

The FreeZone Freeze Dry System is designed to be chemically resistant to most compounds that are commonly used in freeze drying processes. However, by necessity, the Freeze Dryer is comprised of a number of different materials, some of which may be attacked and degraded by certain chemicals. The degree of degradation is dependent on the concentration and exposure duration. Some of the major components of the FreeZone Freeze Dry System that are susceptible to degradation are as follows:

Component	Material	Acids			Buffers		Solvents							
		Acetic Acid 20%	Formic Acid	Trifluoroacetic Acid (TFA)	Calcium Chloride	Sodium Phosphate	Acetone	Acetonitrile	Carbon Tetrochloride	Cyclohexane	Dioxane	Methyl t-Butyl Ether (BTBE)	Pyridine	
Valve Stem	Acetal (Delrin)	C	D	D	D		D							
Collector* Lid	Acrylic			D			D	D	D					
Hoses, Gaskets & Valve Bodies	Neoprene	C	D	D			C	C	D	D	D	C	D	
Flask Top	Silicon Rubber		C	D		D			D	D	D	C	D	
Chamber & Fittings	Stainless Steel				C									

\* An accessory glass lid is available.

C – Moderate degradation; Limited use.

D – Severe degradation; infrequent use recommended; immediate thorough cleaning required.

- Most common compounds used in freeze drying processes, if allowed to enter the vacuum pump, will degrade the oil and cause damage to the vacuum pump.
- Sugars and proteins typically will have minimal negative effect on any of the materials of construction.

When using compounds in the Freeze Dryer that are hostile to the materials of construction, it is imperative the equipment is thoroughly cleaned after use.

- Rubber and plastic components that have been exposed to damaging compounds should be removed and flushed with water.
- The oil in the vacuum pump should be checked often. It must be changed if it is cloudy, shows particles or is discolored. The useful life of vacuum pump oil can be extended if the vacuum pump is operated for an extended period of time after a freeze dry run. This allows contaminants to be purged from the hot oil. This must be done with the inlet to the pump blocked off to prevent air from free flowing through the pump. This is accomplished by closing all sample valves on a clean, dry freeze dry system and turning on the vacuum pump. If the pump is operated at an elevated vacuum level (> 10mBar), oil may be expelled from the pump and damage could occur.

Another way to extend the life of the vacuum pump is to install an optional secondary trap in the line between the Freeze Dryer and the vacuum pump. Contact Labconco for ordering information.

With prudent maintenance the FreeZone Freeze Dry System will provide years of service. Warranty on the affected parts will be voided if maintenance has been obviously neglected. If you have questions about using specific compounds in the Freeze Dryer, contact Labconco Technical Service at 1-800-821-5525 or 816-333-8811 or e-mail: [labconco@labconco.com](mailto:labconco@labconco.com).



## Solvent Safety Precautions

**Solvents used in the Freeze Dryer may be flammable or hazardous to your health. Use extreme caution and keep sources of ignition away from the solvents. When using flammable or hazardous solvents, the vacuum pump must be vented to a fume hood.**

**Hazardous materials such as strong acids or bases, radioactive substances and volatile organics must be handled carefully and promptly cleaned up if spilled. If a sample is spilled in the collector chamber it must immediately be cleaned up.**

**WARNING: The disposal of substances used in connection with this equipment may be governed by various Federal, State or local regulations. All users of this equipment are urged to become familiar with any regulations that apply in the user's area concerning the dumping of waste materials in or upon water, land or air and to comply with such regulations.**

---

# CHAPTER 4

## USING YOUR FREEZE DRYER

After your Freeze Dryer has been installed as detailed in *Chapter 3: Getting Started*, you are ready to begin using your Freeze Dryer. Read this chapter to learn how to:

- operate the controls.
- understand the display.
- connect samples.



**Do not use the Freeze Dryer in a manner not specified by the manufacturer (refer to *Appendix C: Freeze Dryer Specifications*). The electrical protection properties of the Freeze Dryer may be impaired if the Freeze Dryer is used inappropriately.**

## Freeze Dryer Controls

The control panel for the Freeze Dryer is shown below with a description about its function.

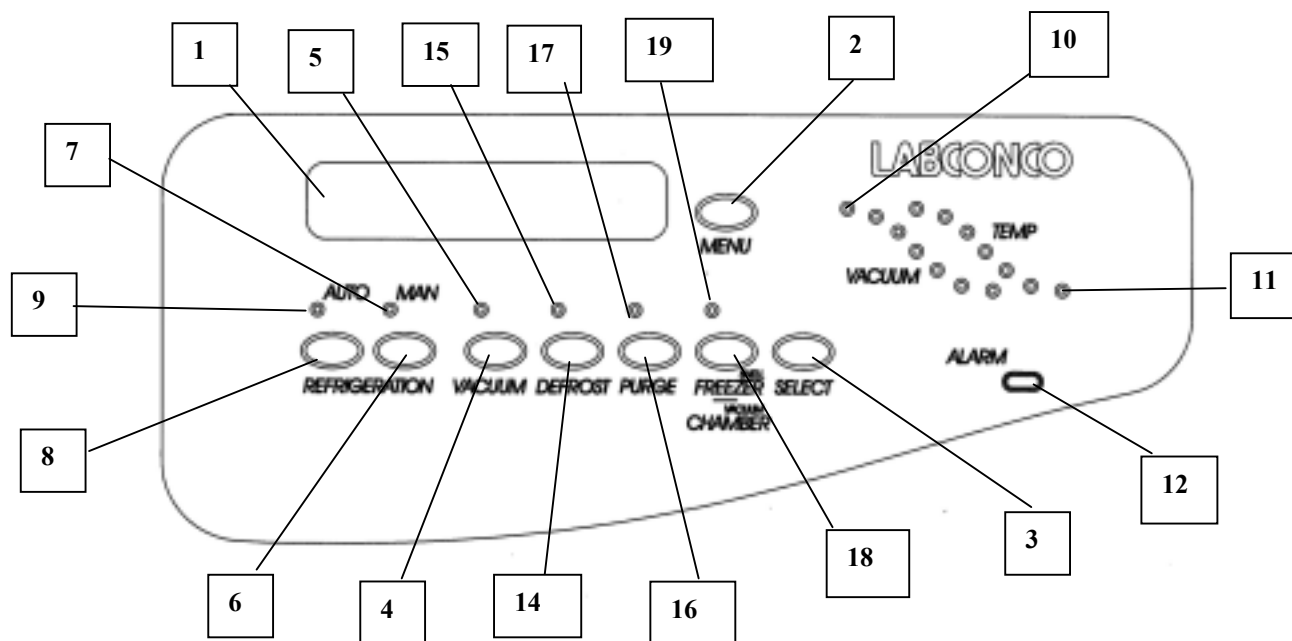

1. LCD Display – Displays system operating parameters, set-up parameters and alarm messages.
2. Menu Switch – This switch is used to change the display from operating system parameters to set-up parameters.
3. Select Switch – Used to select set-up parameters.
4. Vacuum Switch – Used to start or stop the vacuum pump when operating in manual start-up mode.
5. Vacuum Indicator – This green LED indicates that power is being supplied to the vacuum pump receptacle on the back of the Freeze Dryer.
6. Manual Refrigeration Switch – Used to start only the refrigeration module.
7. Manual Operation Indicator – When lit, the green LED indicates the Freeze Dryer is being controlled manually by the operator. The operator must start each function.
8. Auto Mode Switch – Used to start or stop the refrigeration and the Auto Mode process.



9. Auto Mode Indicator – When lit, the green LED indicates that the Freeze Dryer is in Auto Mode. In this mode, the vacuum pump will start when the collector temperature reaches  $-40^{\circ}\text{C}$ .
10. Vacuum Graph Display – This display indicates the relative system vacuum level. The highest LED indicates that the vacuum level is above 2.0 mBar. The indicators will sequence down when the vacuum level reaches 2.0, 1.0, 0.8, 0.6, 0.45, 0.12 mBar. The lower green LED flashes when the system vacuum level is 0.45 to 0.12 mBar and illuminates steadily below 0.133 mBar.
11. Collector Temperature Graph Display – This display indicates the temperature of the collector. The highest LED indicates the collector temperature is warmer than  $10^{\circ}\text{C}$ . The indicators will sequence down when the temperature reaches 10, 0,  $-10$ ,  $-20$ ,  $-30$ ,  $-40^{\circ}\text{C}$ . When the collector temperature is  $-40^{\circ}\text{C}$  or lower the green indicator will light.
12. Alarm Indicator – This red LED indicates that a system alarm has occurred. Press the Menu Switch to display the alarm message on the LCD display.
13. Main Power Switch – Turns the Freeze Dryer on or off. (Not shown, located on the left side of the cabinet.)
14. Defrost Switch – Used to defrost ice from the collector coil.
15. Defrost Indicator – This green LED illuminates when the Freeze Dryer is in defrost mode.
16. Purge Valve Switch – Used to open or close the purge valve, if the model is so equipped.
17. Purge Valve Indicator – This green LED illuminates when the purge valve is closed.
18. Shell Freezer/Vacuum Chamber Switch – Used to operate the shell freezer or the heater on the vacuum chamber if the model is so equipped.
19. Shell Freezer/Vacuum Chamber/Indicator – This green LED illuminates when either the shell freezer or vacuum chamber heater is operating.

## Operation Checklist

The following checklist should be followed prior to each use of your Freeze Dryer:

1. Wipe the interior of the collector chamber with a soft cloth or paper towel to remove any accumulated moisture.
2. Check the collector chamber drain hose to ensure that the hose is free of moisture and that the drain plug is securely installed. The Freeze Dryer will not start if moisture is detected.
3. Using a soft, lint-free cloth or paper towel, wipe the collector chamber lid gasket to remove any dirt and contaminants that could cause a vacuum leak. Vacuum grease is not required on the lid gasket to obtain a proper vacuum seal.
4. Remove the accessory drying chamber or manifold from the connection port and using a soft, lint-free cloth or paper towel, wipe the port gasket and sealing surfaces of the drying chamber/manifold to remove any dirt and contaminants that could cause a vacuum leak. Reinstall the drying chamber or manifold on the port. Vacuum grease is not required on the port gasket to obtain a proper vacuum seal.
5. Inspect each sample valve on the accessory drying chamber or manifold and check for any visible damage and for improper installation that might cause a vacuum leak. Also check that each sample valve is closed or in the “vent” position.

## Vacuum Pump Ballast Setting

Most vacuum pumps are equipped with a gas ballast mechanism. The freeze dry process requires high vacuum. Therefore, it is recommended that the gas ballast be closed during the operation of the Freeze Dry System. If the gas ballast is left open for extended periods of operation, the oil can be pumped out the exhaust, causing the pump to fail.

## Purge Valve

The optional purge valve is installed between the Freeze Dryer collection chamber and the vacuum pump. When the green LED above the PURGE switch is illuminated, the purge valve is closed and the vacuum pump is isolated from the Freeze Dryer collection chamber.

During Freeze Dryer start-up, the refrigeration system pulls the collector coil down to temperature. While the collector coil cools, the purge valve can be closed and the vacuum pump allowed to

run. This allows the vacuum pump oil to warm, which will evaporate and expel condensed solvents from the oil. When the collector coil is down to

temperature and the freeze dry process is started, the warm pump oil is less likely to condense solvent vapors that are not trapped by the collector coil. When the Freeze Dryer is operated in the Automatic Mode, the purge valve and vacuum pump will operate automatically to perform this function. In the Manual Mode the user must manually activate the purge valve and vacuum pump to perform this function.

During shut down the vacuum pump can be run for several minutes with the purge valve closed. This will allow the warm pump oil to evaporate and expel solvent vapors that condensed in the pump oil during the freeze dry process. Whether the Freeze Dryer is run in the Automatic Mode or the Manual Mode, the user must manually activate the purge valve and vacuum pump to perform this function.

If power to the Freeze Dryer is interrupted during the freeze dry process, the purge valve will open during the power outage, and the vacuum bleed valve will open to allow atmospheric air to enter the system.

## Operating the Freeze Dryer

### Set-Up

The Freeze Dryer may be configured to automatically start the vacuum pump when the collector temperature reaches  $-40^{\circ}\text{C}$ . The display units for vacuum may be selected to be mBar, Pascal (Pa) or Torr and the temperature may be displayed as  $^{\circ}\text{F}$  or  $^{\circ}\text{C}$ . The run time of the refrigeration system and the vacuum pump may be monitored.

To configure your Freeze Dryer, turn the main power switch ON and press MENU. The display will show:

VACUUM UNITS		
mBar	Pa	Torr

- Press SELECT until the desired units are flashing.
- Press MENU.
- The display will show:

VACUUM SET POINT	
XXXX	YYY

Where YYY is the units selected above.

- Press SELECT until the desired vacuum operating level is displayed. See “Setting the Operating Vacuum Level” for guidelines.
- If “0” is selected, the vacuum control is disabled and the vacuum level in the Freeze Dry System will be determined by the capabilities of the vacuum pump.
- Press MENU.
- The display will show:

TEMPERATURE UNITS

°C            °F

Press SELECT until the desired units are flashing is displayed.

Press MENU.

The display will show the following screen if the Freeze Dryer is equipped with a Drying Chamber.

DRYING CHAMBER SETPOINT:

XX Y

When Y is the units selected above.

- Press SELECT until the desired temperature is displayed.
- Press MENU.
- The display will show:

REFRIG TOTAL HOUR: XXXX  
SERVICE HOUR: XXXX

- To reset the SERVICE HOUR to 0 press SELECT. This allows you to keep track of the time the refrigeration system operated since it was serviced.
- The display will show the refrigeration system hours.

REFRIG TOTAL HOUR: XXXX  
RESET SERVICE HOUR: ?



## **Baffle**

### **(6 Liter –84°C Cascade model, 12 Liter –84° Cascade model & 18 Liter Model)**

Position the baffle so it rests on the top of the collector coil. The arrow should point toward the front.

## **Automatic Start-Up**

### **(Models not equipped with a purge valve)**

To run the Auto Mode, press the panel switch labeled REFRIGERATION AUTO. The green LED above the switch will illuminate. This will start the refrigeration system. When the collector reaches –40°C, the vacuum pump will start. The Temperature and Vacuum Graphs will indicate collector temperature and system vacuum. The LCD display will show the actual temperature of the collector. When the vacuum in the system is above 5 mBar the vacuum display will indicate “HI.” At 5 mBar and below, the display will show the actual vacuum.

When the system vacuum is between 0.450 and 0.133 mBar, the lower green vacuum graph LED will flash. When the system vacuum level is <0.133 mBar, the green LED will be lit steadily indicating that most samples may be added.

## **Automatic Start-Up**

### **(Models equipped with a purge valve)**

To run the Auto Mode, press the panel switch labeled REFRIGERATION AUTO. The green LED above the switch will illuminate. The LED's above the vacuum and purge switches will also illuminate. The refrigeration system and vacuum pump will start and the purge valve will close. When the collector reaches –40°C, the purge valve will open. The Temperature and Vacuum Graphs will indicate collector temperature and system vacuum.

The LCD display will show the actual temperature of the collector. When the vacuum in the system is above 5 mBar the vacuum display will indicate “HI”. At 5 mBar and below, the display will show the actual vacuum. When the system vacuum is between 0.450 and 0.133 mBar, the lower green vacuum graph LED will flash. When the system vacuum level is <0.133 mBar, the green LED will be lit steadily indicating that most samples may be added.

## Manual Start-Up

**(Models not equipped with a purge valve)**

To manually run the freeze dry process, press the REFRIGERATION MAN switch. This will start the refrigeration system. The green LED above the switch will illuminate. When the collector temperature reaches  $-40^{\circ}\text{C}$ , the vacuum pump may be started by pressing the VACUUM switch. The Temperature and Vacuum Graphs will indicate collector temperature and system vacuum. The LCD display will show the actual temperature of the collector. When the vacuum in the system is above 5 mBar the vacuum display will indicate “HI.” At 5 mBar and below, the display will show the actual vacuum.

When the system vacuum is between 0.450 and 0.133 mBar, the lower green vacuum graph LED will flash. When the system vacuum level is  $<0.133$  mBar, the green LED will be lit steadily indicating that samples may be added.

## Manual Start-Up

**(Models equipped with a purge valve)**

To manually run the Freeze Dryer, press the REFRIGERATION MAN switch. The green LED above the switch will illuminate. The PURGE switch and VACUUM switch may be pressed. LED's above the switches will illuminate. The purge valve will close and the vacuum pump will start. (Do not start the vacuum pump without first closing the purge valve). When the collector temperature reaches  $-40^{\circ}\text{C}$  or any time afterwards, press the PURGE switch to open the purge valve. The Temperature and Vacuum Graphs will indicate collector temperature and system vacuum. The LCD display will show the actual temperature of the collector. When the vacuum in the system is above 5 mBar the vacuum display will indicate “HI”. At 5 mBar and below, the display will show the actual vacuum.

When the system vacuum is between 0.450 and 0.133 mBar, the lower green vacuum graph LED will flash. When the system vacuum level is  $<0.133$  mBar, the green LED will be lit steadily indicating that samples may be added.

## Setting the Operating Vacuum Level

The vacuum level may be set by the user to optimize the freeze dry process. Normally, the sublimation rate will increase if there is less vacuum (a higher pressure) in the Freeze Dryer. A good starting place is to set the vacuum so its level is equivalent to about 10°C colder than the eutectic or collapse temperature of the sample. Adjustments to the vacuum level must be made for various freeze drying conditions. Factors that must be considered are whether the sample is freeze dried on heated shelves or in glassware attached to manifold valves, the volatility of the sample itself, the size of the sample and the heat energy supplied to the sample.

When the vacuum control is set to operate at less vacuum, the ice holding capacity of the collector may be decreased. This can be improved in non-cascade models by installing a baffle in the collector. See Appendix D Freeze Dryer Accessories for the baffle part number. See the section titled Baffle in this chapter for proper installation.

Some guidelines for setting the Freeze Dryer are shown below. These show pre-freezing temperatures and vacuum levels. Exact protocols must be determined by the user for the specific samples that are being freeze dried.

Material	Solidification/Eutectic Temperature	Pre-Freeze Temperatures	Vacuum Set Point
Bacteria, Virus	-40°C and Colder	-50°C & Colder	0.040 mBar & Lower
Milk	-5 to -13	-15 to -23	1.65 to 0.77
Fungi	-40 and Colder	-50 & Colder	0.04 and lower
Vegetable Tissue	-25 to -50	-35 to -60	0.22 to 0.01
Human Tissue	-30 to -40	-40 to -50	0.12 to 0.04
Blood Plasma	-10 to -25	-20 to -35	1.03 to 0.22
Vaccine	-30 to -40	-40 to -50	0.12 to 0.04

## Pre-Freezing Samples

Appropriate containers for freeze drying include ampules, serum bottles, and wide mouth freeze drying flasks. Shell freezing of samples is recommended for wide mouth freeze drying flasks. Smaller samples in ampules and serum bottles may be frozen in a freezer. The sample container size should always be at least two to three times the sample size (i.e., 40 ml samples should be prepared in 80 ml containers or larger). The temperature required for pre-freezing is dependent on the characteristics of the sample. Pre-freezing temperature typically is at least 10° to 20°C below the eutectic or collapse temperature of the sample.



## Adding Sample

The following procedure should be followed when using sample valves in the freeze dry process:

1. Connect a pre-frozen sample to a sample valve on the drying chamber or manifold using an adapter. Turn the plastic valve knob to the “VACUUM” position to open the valve. The bevel on the knob should be positioned toward the sample port to apply vacuum to the sample.

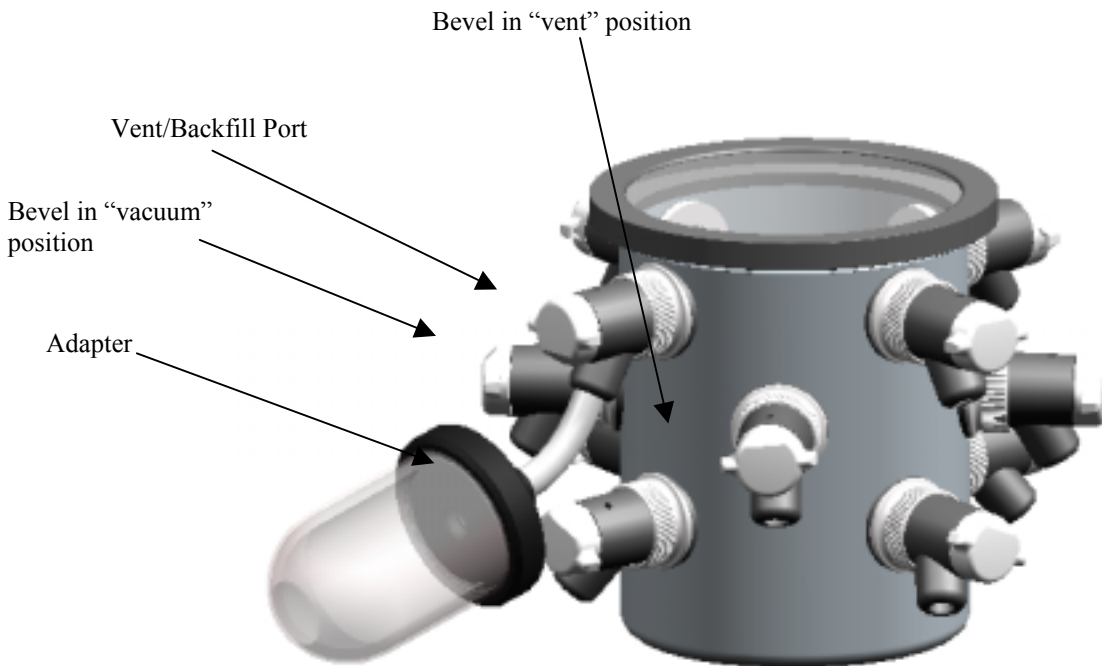

2. Before adding another sample, allow system vacuum to return to 0.133 mBar or lower. Any combination of valves and sample sizes may be utilized at one time provided that the system vacuum and collector temperature remain sufficiently low to prevent melting of the frozen sample.
3. When all the frost has disappeared from the outer surface of the sample container and no cold spots can be detected by handling the container, the sample is nearly dry. To be certain of low final moisture content, dry the sample for several hours past this point.
4. To remove a container after drying is complete, turn the plastic knob on the valve to the “VENT” position, which closes the valve and vents the container. Should backfilling with an inert gas be required, connect the gas supply line to the vent port on the valve before turning the plastic knob on the valve to vent

- position. The sample container may now be removed. In the vent position the bevel on the valve knob should point away from the sample port.
5. Ampules may be flame sealed while connected to a valve by using a sealing torch. Care must be taken not to burn the valve. An insulation material placed between the valve and the torch is recommended.

## Shut Down

At the end of a run or when a sufficient amount of condensate accumulates on the collector coil to obstruct the flow of vapor to the collector chamber, the Freeze Dryer should be defrosted. First, release system vacuum by turning the plastic knob on a valve to the open position or by pulling the collector chamber drain plug out of the drain hose. Now press the Vacuum Switch on the control panel to turn the vacuum pump OFF. Press the Refrigeration Switch next to the illuminated LED to turn OFF the refrigeration system. Turn OFF the Main Power Switch on the left hand side of the cabinet.

After a run is complete, it may be desirable to purge contaminants from the vacuum pump oil. This can be accomplished by first closing the purge valve by pressing the purge switch. The LED will illuminate. Then turn on the vacuum pump by pressing the vacuum switch, let the pump operate for an extended period of time.

## Defrosting

The following procedure should be followed when defrosting the collector coil:

1. Pull the collector chamber drain hose out from the front panel of the unit and remove the drain plug. Place the drain hose in a suitable container to collect the condensate that will be defrosted off the collector coil.
2. Press the DEFROST switch on the control panel. The green LED above that switch will illuminate. Allow unit to operate in this condition until all condensate is defrosted from the collector coil. Dispose of the liquid appropriately.
3. Lift out the ice plug after it has melted sufficiently to be removed without force.
4. Flush the collector chamber with water and wipe chamber dry.
5. If rapid defrost is desired, pour warm water into the collector chamber covering no more than the bottom 2 coils. **If excess**

**water is added it can enter the vacuum port and drain into the vacuum pump.**

6. Press the DEFROST switch, the green LED will be off. Reinstall the drain hose plug and slide drain hose back into cabinet through the front panel. Dispose of the liquid appropriately.



**Utilization of acid requires immediate cleaning and neutralization after defrost or physical damage to the collector chamber and collector coil will result.**

**Do not attempt to chip ice from the collector coil as damage may occur to the coil.**

**Never attempt to start the vacuum pump when there is liquid in the collector chamber. This could result in damage to the vacuum pump.**

## Operating the Shell Freezer

The optional built in shell freezer is designed for shell freezing samples in flasks in preparation for freeze drying.

Follow the steps below each time you use the shell freezer to obtain optimum performance:

1. Check that the solvent bath drain plug is securely installed in the drain hose.
2. Remove the bath compartment cover and add solvent to the bath compartment. Commonly used solvents are methanol or ethanol. Recommended solvent depth is ¼" to ½" above the top of the rollers (approximately 2 liters).



**If flammable solvents are used in the shell freezer bath, be sure to keep away from open flame.**

3. Press the panel switch labeled SHELL FREEZE. The green LED above the switch will illuminate. The shell freezer refrigeration module will start and the bath rollers will begin rotating. The LCD display will show the shell freezer bath temperature.
4. Fill a freeze dry container no more than ½ full with sample and stopper the container top. Lay the container on the rollers in a

horizontal position. Replace the bath compartment cover during shell freezing.

5. When the sample is completely frozen in the container, remove the container from the bath compartment and freeze dry the sample or place it in a suitable storage freezer for future freeze drying.
6. Press the SHELL FREEZE switch to turn shell freezer off.

7. If the Shell Freezer is to be used for cold bath operation, additional solvent may be added to submerge small flasks. Do not fill pan more than 2 inches below the top of the stainless steel pan with vessels submerged. Allow additional time for larger volumes of solvent to pull down in temperature.
8. Always drain flammable solvents from the bath when the shell freezer is not in use and store the solvent in a suitable container. This is accomplished by first pulling the drain hose out of the front panel of the unit and then removing the drain plug. Place the hose in a suitable container to collect the solvent.



## Operating the Vacuum Drying Chamber

The built-in drying chamber is designed for freeze drying small samples, either in bulk or in small containers such as vials or 96 well plates. It may be used in conjunction with other drying accessories that are mounted on top of the Freeze Dryer or independently. If a manifold or chamber is mounted to the Freeze Dryer and is not in use, close all of its valves. If no drying accessory is installed on the Freeze Dryer, place the supplied stopper in the center of the 3.0 accessory port that is on the top of the Freeze Dryer to seal the vacuum system. Follow the steps below to operate the built-in drying chamber.

1. Start the Freeze Dryer. Position the Vacuum Chamber valve on the top of the Freeze Dryer to the VENT position. Turn on the refrigeration in the Freeze Dryer in the MAN or AUTO mode according to the instructions in this manual. If the sample will be prefrozen in the collector chamber, the Freeze Dryer must be started in the MAN mode.
2. Set the Drying Chamber temperature according to the Set Up instructions in this manual. The set temperature should be lower than the eutectic temperature of the sample.

**NOTE:** The Drying Chamber is NOT refrigerated. If the operating temperature is set below ambient, the only source cooling the chamber is the sample itself.

3. Press the switch marked Shell Freezer/Vacuum Chamber to actuate the heater.
4. Freeze the sample. Before the freeze dry process can occur, the product to be freeze dried must be in a frozen state. This can be done in a separate freezer or in the Freeze Dryer collector chamber.
5. Load the samples. The Freeze Dryer collector temperature must be – 40°C or colder. Replace the chamber lid.
6. Start primary drying. Turn the vacuum control valve on the top of the Freeze Dryer to VACUUM. Start the vacuum pump if the Freeze Dryer was started in the MAN mode.
7. Start secondary drying. After all the free moisture is removed in the primary drying phase, the temperature of the chamber may be increased. Do this according to the instructions in the Set Up section of this manual.
8. Shut Down. After completion of the freeze dry procedure:
  - a. Press the Shell Freezer / Vacuum Chamber Switch to turn off the chamber heater.
  - b. Release vacuum in the chamber by turning the valve on the top of the Freeze Dryer to VENT.
  - c. Remove the sample.
  - d. Release vacuum from the Freeze Dryer by either opening the Vacuum Chamber valve when the chamber lid is off or by removing the drain plug or by opening a valve on chamber or manifold mounted on top of the Freeze Dryer. Turn off the vacuum pump.
  - e. Turn off the Freeze Dryer, defrost and drain the chamber per instructions in this manual.

## Alarms

A number of unusual events may occur during a lyophilization procedure that can adversely effect the operation of the Freeze Dryer. If an event occurs, the alarm indicator will flash and the beeper will sound.

The beeper will automatically mute itself after one minute. The specific alarm can be identified by pressing MENU. Pressing MENU multiple times will display multiple alarms if they have occurred. The following “out of specification” conditions will initiate an alarm:

## Power Failure

If a power failure occurs during a Freeze Dry process, the vacuum control valve will allow air to bleed into the Freeze Dryer System.

If the failure is of a short duration and the collector does not warm up excessively, when power is restored, the Freeze Dryer will restart and resume operation of the refrigeration and vacuum systems. If the power failure lasts for a longer duration and the collector warms above safe limits, when the power is restored, the Freeze Dryer will not restart by itself. This prevents melted sample from being drawn into the collector and prevents liquid from being sucked into the vacuum pump. When power is restored, the alarm indicator will flash and the alarm beeper will sound. When the MENU button is pressed the display will show

POWER FAIL  
HOLD SELECT TO CLEAR IT

Press and hold SELECT for five seconds until the error message is cleared from the display.

## Line Voltage Out of Range

If the voltage supplied to the Freeze Dryer varies beyond allowable limits, the alarm will be activated. When an alarm occurs, press MENU and the display will show:

LINE VOLTAGE ERROR

The alarm will self-cancel when the proper voltage is restored. The high and low alarm points are preset at the factory to correspond to the normal allowable voltage variations based on the nominal voltage specified for the freeze dryer. Some models may be operated outside the normal voltage limits. See *Appendix C*.

If necessary, the high and low alarm points may be adjusted for these models. See *Chapter 8*.

## Temperature Out of Range

An alarm will be activated if the collector temperature rises above  $-40^{\circ}\text{C}$ . If this occurs, the display will show:

COLLECTOR TEMPERATURE  
HOLD SELECT TO CLEAR IT

Press and hold SELECT for five seconds until the error message is cleared from the display.

## Service Vacuum Pump

The vacuum pump normally plugs into the vacuum pump electrical receptacle on the back of the Freeze Dryer. When the Freeze Dryer has accumulated a total of 1000 operating hours, the alarm indicator will flash. Press MENU to display the alarm:

CHANGE VACUUM OIL  
HOLD SELECT TO CLEAR IT

Press and hold SELECT for five seconds until the error message is cleared from the display.

This will reset the 1000 hour timer. It may be necessary to service the vacuum pump more frequently than every 1000 hours depending on the operation of the Freeze Dryer. The pump oil should be regularly monitored to verify that it is clean.

## Moisture in Collector

If there is liquid in the collector chamber and either a REFRIGERATION button or the VACUUM button is pressed, neither function will start and an alarm will be activated. When MENU is pressed, the display will show:

MOISTURE IN COLLECTOR

When the collector is drained, the alarm will self-cancel.

This feature prevents the inadvertent start of the vacuum pump when liquid is in the collector and thereby can extend the life of the vacuum pump. A few drops of liquid may remain in the drain hose after draining. When the vacuum pump is started these drops may be sucked into the collector chamber. This is normal.

---

# CHAPTER 5

## MAINTAINING YOUR

### FREEZE DRYER

Under normal operation, the Freeze Dryer requires little maintenance. The following maintenance schedule is recommended:

**As needed:**

1. Clean up all spills; remove liquids from the chamber.
2. Clean lid and gasket using soft cloth, sponge or chamois and a mild, non-abrasive soap or detergent.
3. Check oil level of the vacuum pump. It should be between MIN and MAX. If the oil level is less than an inch (25.4 mm) above MIN, add oil to proper level.
4. If oil shows cloudiness, particles or discoloration, drain the pump and replace with fresh oil.
5. **Utilization of acids requires immediate cleaning and neutralization after a run or physical damage to the collector chamber and collector coil will result.**
6. Check the collection chamber for condensed or frozen solvents and dispose of appropriately. Completely empty the collector chamber before the next run or before attempting to start the vacuum pump.
7. If sample valves leak or stems become difficult to turn, pull the stem out of the rubber valve body and apply a thin coat of vacuum grease to the stem. Reinsert the stem into the valve body.



**Monthly:**

1. The rubber components on the Freeze Dryer may eventually deteriorate and require replacement. The effective life of rubber parts depends upon both their usage and the surrounding environment. Check all rubber hoses and gaskets and replace any that show signs of hardening, permanent set or deterioration.
2. Using a soft cloth, sponge or chamois and a mild, non-abrasive soap or detergent, clean the acrylic chamber lid.
3. Using a soft cloth, sponge, or chamois and a mild, non-abrasive soap or detergent, clean the exterior surfaces of the Freeze Dryer. Liquid spray cleaners and polishes may be used on the exterior surfaces. Do not use solvents to remove stains from the exterior surfaces as they may damage the finish.

**Annually:**

1. Every 12 months, or more often if the Freeze Dryer is operated in a dusty environment, the refrigeration system condenser should be cleaned. Using a vacuum cleaner with brush attachment, clean the condenser to ensure proper airflow for peak performance.

---

# CHAPTER 6

## USING THE RS232

### RECEPTACLE

The operation of the Freeze Dryer can be monitored using a computer when it is connected to the RS232 receptacle on the rear panel. The computer cannot control the operation of the Freeze Dryer. The monitored parameters are the collector temperature in °C and vacuum in microbars.

When a Labconco Stoppering Tray Dryer is connected to a Labconco Freeze Dryer as detailed in the Stoppering Tray Dryer User's Manual, the status of the Stoppering Tray Dryer may be monitored simultaneously with the status of the Freeze Dryer.

### Computer Connection for Computer Interface

Check your computer to see which type of serial port is provided, then use a connecting cable below:

1. Computers with a 25 pin D-sub male serial connector should use Connect Cable, Labconco part number 7537801, to connect a computer to the Labconco Freeze Dryer.
2. Computers with a 9 pin D-sub male serial connector should use Connect Cable, Labconco part number 7537800, to connect a computer to the Labconco Freeze Dryer.

The purpose of the RS232 interface is to send data to a data logging computer to monitor the state and activity of the Freeze Dryer. This data is half duplex data. The data properties are as follows:

1. Data Rate 2400 Baud
2. 8 Bit word length
3. 1 Start bit, 1 Stop bit
4. No parity is transmitted
5. Standard ASCII character set

The time between data transmissions may be varied by the user to occur at 10, 30, 60, 300 or 600 second intervals. Press the MENU button until the RS232 screen appears on the display.

RS-232 TRANSMISSION RATE	
10	SECONDS

Press select until the desired time interval is shown.

The format of the transmitted message is as follows:

B<T= -48 V= 18 SF = 999 C=999 PG=9 >

Where:

- B = Base Unit
- T = Collector Temperature
- 48 = Collector Temperature in °Celsius
- V = Vacuum
- 18 = Vacuum Level in Micro Bars
- SF = Shell Freezer Temperature (if so equipped)
- 9 = Feature not installed or out of range
- C = Vacuum Chamber Temperature (if so equipped)
- PG = Purge (if so equipped)
- 1 = On
- 0 = Off

If a Stoppering Tray Dryer is attached to the Freeze Dryer and the data interconnect cable is installed, additional data about that accessory will be transmitted from the Freeze Dryer. See the User's Manual for the Stoppering Tray Dryer for a description of the data.

There are several commercially available software packages, which can read RS232 data and enter the data into a computer program such as a word processor (to create a text file) or

spreadsheet (to tabulate and plot the data). Consult your laboratory supply dealer regarding the latest software available. The following describes how to use an IBM compatible computer with Hyper Terminal™ software (included with Windows® 95, 98, XP or 2000 operating systems) to collect the RS232 data from your Freeze Dryer:

1. Make sure that the Freeze Dryer is properly connected to the communication port on the computer.
2. Open Hyper Terminal™ software.

i) Windows® 95 or 98 use:  
START/PROGRAMS/ACCESSORIES.

ii) Windows® 2000 or XP use:  
START/PROGRAMS/ACCESSORIES/COMMUNICATIONS

The first time Hyper Terminal™ is opened a dialogue box requesting an area code and phone number will appear. Enter the appropriate numbers and continue.

3. The “Connection Description” dialogue box will open. Type in a user defined name and select an icon for the new connection. Press “OK.”



4. The “Connect To” dialogue box will open. Using the down arrow selection button, select the communication port to which the cable has been connected. Press “OK.”



5. The “Com X Properties” dialogue box will open. Enter the appropriate data properties and press “OK.”

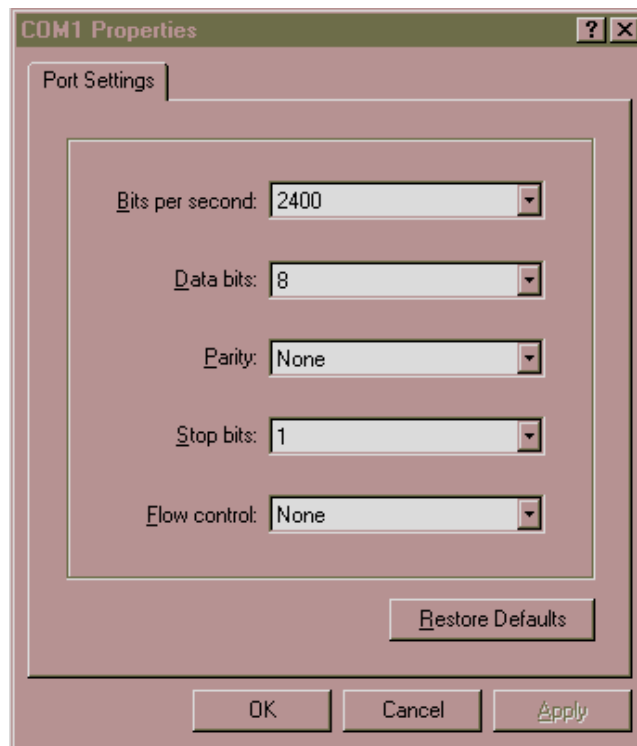

- When the Freeze Dryer main power switch is on, the data will be transmitted and updated at the time intervals selected by the user.

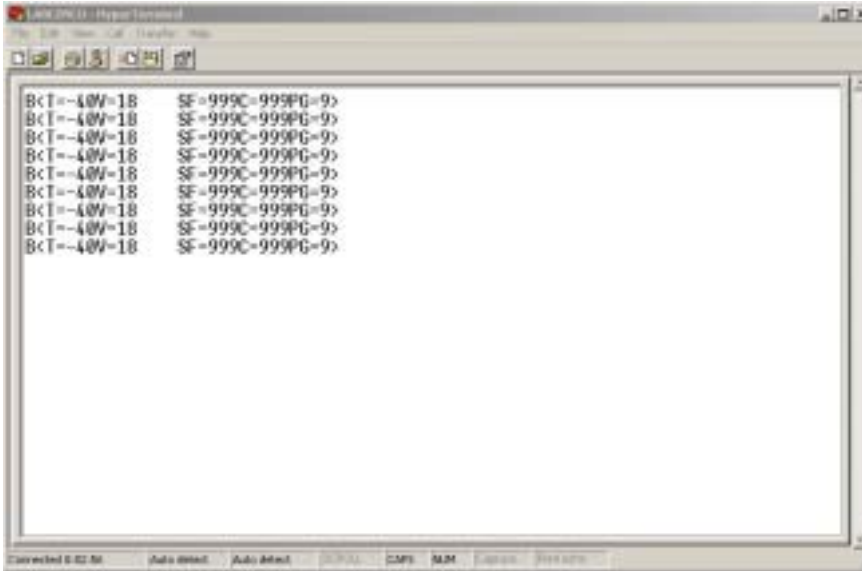

---

# CHAPTER 7

## TROUBLESHOOTING

Refer to the following if your Freeze Dryer fails to operate properly. If the suggested corrective actions do not solve your problem, contact Labconco for additional assistance.

Labconco Freeze Dry Systems that are clean, dry and without samples attached should reach a vacuum of 0.133 mBar within 10 minutes and should achieve an ultimate vacuum of 0.033 mBar within 18 hours when the refrigeration is operating. If the Freeze Dryer does not obtain a satisfactory vacuum, perform the following maintenance tests.

### I. Vacuum Pump

First make sure that the vacuum pump operates. If it fails to operate, check the electrical connections of the Freeze Dryer to the power source and then check the electrical connection of the vacuum pump to the Freeze Dryer. If the vacuum pump has a power switch, make sure that it is turned on. If the vacuum is not adequate when the vacuum pump is operating, proceed with the following steps:

1. Check the oil and ensure it is clear and clean. If the oil looks cloudy or has any particulates, replace the pump oil. Sometimes it may be necessary to flush the pump with clean oil several times. To flush the pump, run the pump 5 to 10 minutes to allow the oil to warm up. Drain the oil and refill with clean oil. Repeat as necessary.
2. Check the oil level in the pump. Ensure it is filled to the correct level.
3. Check vacuum hose connections from the pump to the Freeze Dryer and try running the unit.

If vacuum problems continue, consider obtaining a second vacuum gauge capable of reading a vacuum of 0.010 mBar. It is often useful in determining if the vacuum pump is operating properly and the vacuum sensor reading is accurate.

4. Isolate the pump by disconnecting the vacuum hose from the Freeze Dryer. Deadhead the pump by inserting the vacuum sensor from a secondary vacuum gauge into the end of the vacuum hose and observe the vacuum reading obtained. Confirm that the pump is capable of achieving an ultimate vacuum less than 0.010 mBar or approximately 10 microns. If an inadequate vacuum reading is obtained, the pump has most likely failed and may need to be replaced or rebuilt.

## II. Gaskets, Tubing, Connections, Sample Valves

1. Check all sample valves on the drying chamber/manifold and ensure all valves are closed or in the vent position. Check to ensure all fittings are tight and sealed properly against the chamber. Inspect valves for cracks or cuts.
2. Inspect gasket(s) for cracks or defects. Ensure the gasket is clean. Apply a thin coat of vacuum grease to the gasket. Keep in mind too much vacuum grease can actually cause leaks.
3. Check the drain line and ensure the drain plug is installed and the tube appears to be in good condition.
4. Check all rubber vacuum tubing for signs of deterioration or cracking.
5. Check all connections and make sure they are secure and leak tight.
6. When checking the sample valves, pull as much vacuum as possible. If a vacuum indication is displayed, wiggle or rotate the valves and watch the gauge for any fluctuations. Fluctuations can indicate a potential vacuum leak. If the valve seems to be in good condition, remove the valve and apply a thin coat of vacuum grease to the stem and the outside sealing surface of the valve body, and reinstall the valve. **DO NOT APPLY VACUUM GREASE TO THE SAMPLE VALVE GASKETS, WHICH SEAL TO THE WALL OF THE DRYING CHAMBER.** If the valve still seems to be the source of the problem, remove the valve and stopper the hole with a rubber stopper. Continue checking the other valves.



7. Make sure that the sample valve bulkhead nuts are tight. Either tighten by hand or use the wrench supplied with chambers. To use the wrench, first remove the knob and stem assembly and also the valve body. The pins on the wrench fit into the round holes of the nut. The nut should be snug, but avoid over-tightening. Replace the valve body, knob and stem assembly.

The illustrations below show how the sample valve installs on a chamber and a manifold.

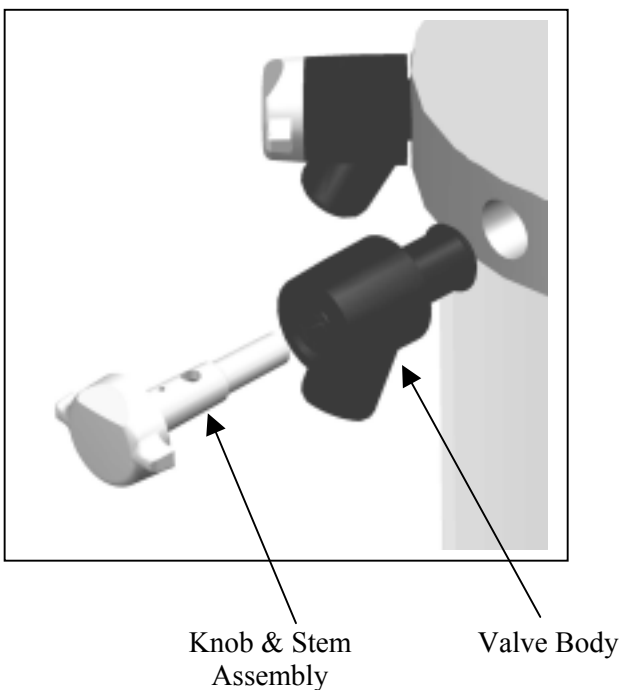

**Valve Assembly (Clear Chamber with Valves)**

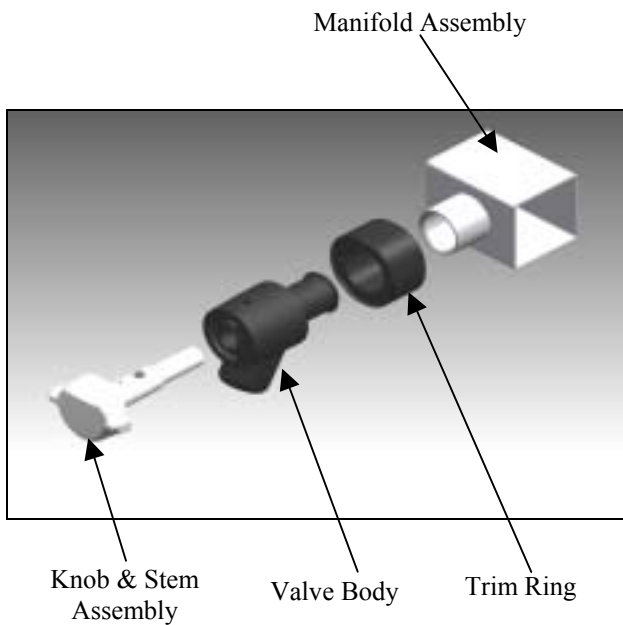

**Valve Assembly (Manifold)**

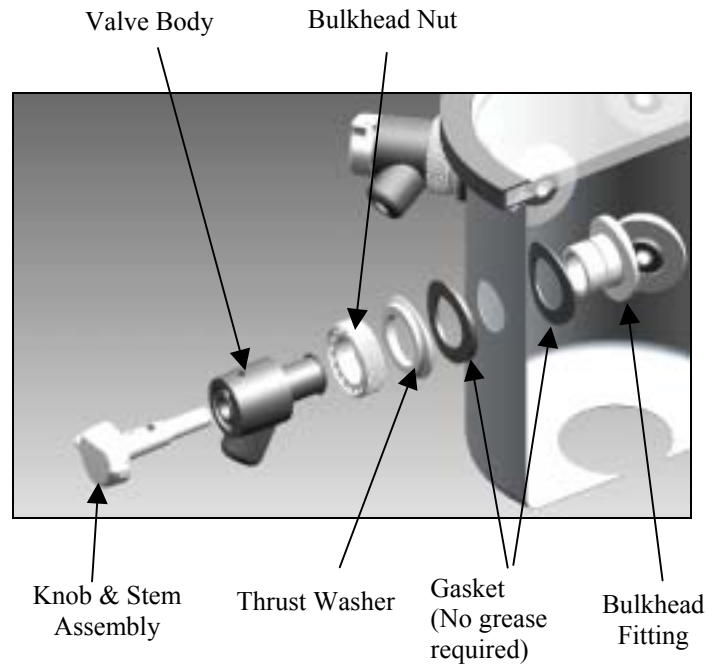

**Valve Assembly (Stainless Steel Chamber)**

### III. System Components and Collection Chamber Isolation

1. Remove the drying chamber or manifold.
2. Leave the gasket on and turn a large freeze dry flask upside down to cover the connection port.
3. Start the freeze dryer and observe the vacuum indication. If the vacuum indication is good, then the problem is in the drying chamber or manifold and you should return to *Section II, Gaskets, Tubing, Connections, Sample Valves*.

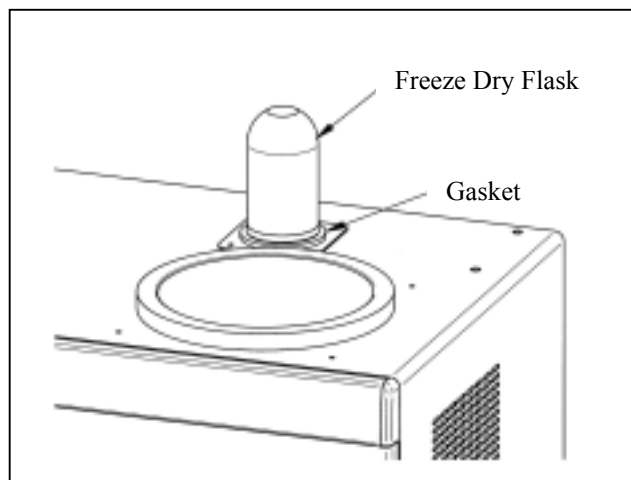

The following test allows you to check the pump and the connections from the pump to the vacuum tube.

1. Place a rubber stopper in the vacuum port in the left side of the collector chamber and another in the drain port in the bottom.
2. Restart the vacuum system and check your vacuum indication. Insufficient vacuum indicates a bad pump or a leak in the connections from the pump to the side of the chamber.

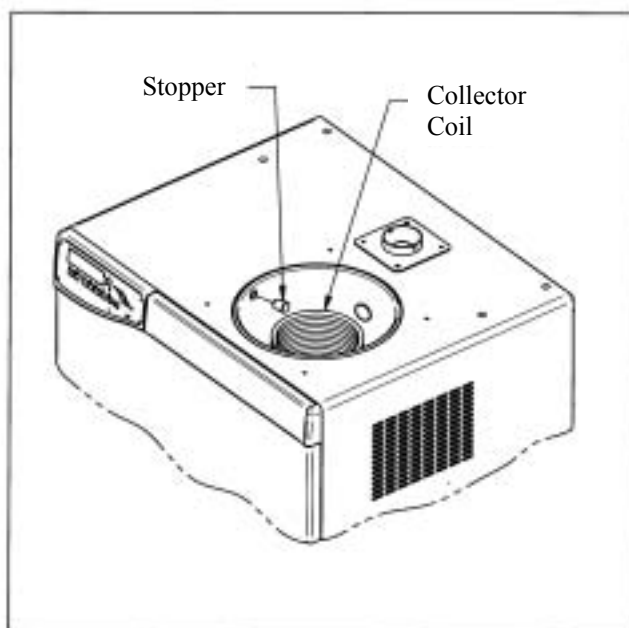

The following test is used to check the collection chamber integrity. The figure below points out potential areas to locate a leak:

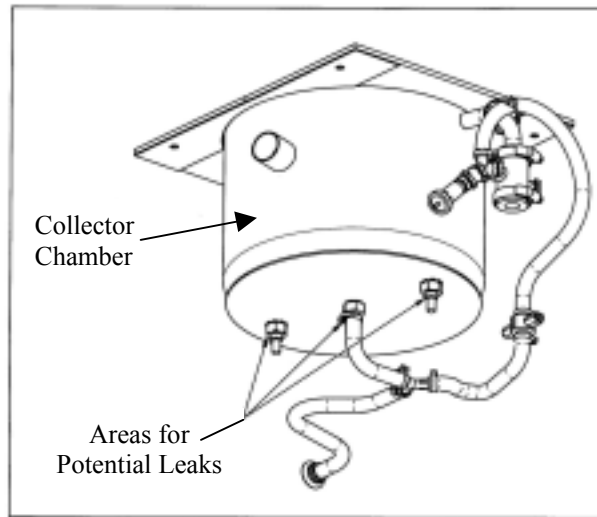

1. Remove the stopper from the side of the chamber and place a freeze dry flask over the connection port.
2. Fill the collection chamber with approximately 2 inches of water, enough to cover all fittings. Replace the collection chamber lid and turn on the vacuum pump. Allow the vacuum pump to run for approximately 5 to 10 seconds. (If the vacuum pump is left on, the water will begin to boil and the test will not be effective). Look inside the chamber for any bubbling while the pump is running and after you shut the pump off.
3. If bubbling is observed around the bulkhead fittings, access the bottom of the chamber and remove the insulation. Tighten the appropriate fitting by placing a wrench on the fitting inside the chamber and use a second wrench to turn the nut on the bottom of the chamber. Be careful not to damage the evaporator coils or the brazed joints to the refrigeration system. Once the fitting is tightened, perform the test again. Should the bubbling still be present, loosen the bulkhead fittings and apply vacuum grease to the O-rings, then reassemble and test.

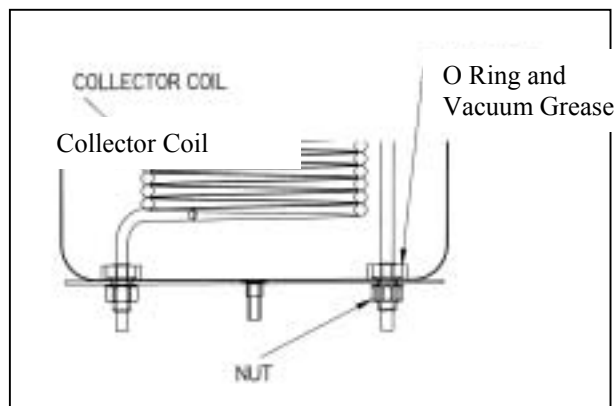

4. If bubbling was observed on the chamber surface, the chamber must be replaced. This type of leak cannot be successfully repaired. The leading cause of a chamber surface leak is corrosive residue left in the chamber after use.

## Refrigeration Module Operation

Under a no-load condition, the FreeZone Single Stage Freeze Dry System can achieve a collector temperature of  $-50^{\circ}\text{C}$  or lower when the system is under vacuum, within 40 minutes when the vacuum pump is running, depending on ambient temperature and humidity. Cascade Freeze Dry Systems will achieve  $-84^{\circ}\text{C}$  within 40 minutes.

Cascade Systems (those that operate @  $-84^{\circ}$ ) consist of two vapor-compression refrigeration systems in series connected together via a heat exchanger. Each system has a compressor, condenser, capillary tube metering device and an evaporator. During operation the evaporator of the “high stage” system refrigerates the condenser of the “low stage” system. This takes place in the heat exchanger. The low stage and high stage systems are balanced by design, however, sometimes that balance can be disrupted during operation and the unit will not function properly. If the unit is overloaded, or if the unit is defrosted and restarted in a short time interval, system unbalance is possible. If system unbalance occurs, turn the Freeze Dryer off and allow the unit to soak at ambient temperature for 2 to 4 hours.

If any repairs are required on the refrigeration module, contact your local laboratory supply dealer. If your laboratory supply dealer is unable to provide assistance, please call Labconco. Repairs should only be undertaken by a competent refrigeration technician or through an authorized Labconco service agency.

---

# CHAPTER 8

## MODIFYING YOUR FREEZE DRYER DISPLAY

Your Freeze Dryer has been carefully calibrated and tested before shipping, however under certain circumstances it may be necessary to adjust the calibration of the temperature and/or vacuum display or to modify alarm points. Adjustments may be necessary if the Freeze Dryer requires service or if it is operating on a line voltage outside the voltage range at which the alarm was preset. This DOES NOT mean that the Freeze Dryer may be operated at a voltage outside the ranges shown in Appendix C.

### Temperature and Vacuum Display

An offset may be added to the collector temperature or vacuum display. Use an accurate traceable reference to compare the readings.

Temperature offset may be varied  $\pm 5^{\circ}\text{C}$  in  $1^{\circ}\text{C}$  increments.  
Vacuum offset may be varied  $\pm 0.020$  mBar in  $0.001$  mBar increments.

### Line Voltage Alarm Points

The Freeze Dryer is designed to alarm if the line voltage varies more than  $\pm 10\%$  from nominal line voltage. Models rated to operate on 115V are preset to alarm if the voltage drops below approximately 103V or rises above approximately 127V. Models rated to operate on 230V will alarm if the voltage drops below

approximately 206V or rises above approximately 254V. Some models are designed to operate below these ranges (see Appendix C). In these cases it is permissible to lower the low voltage alarm point to prevent nuisance alarms from occurring.

Low line limit may be lowered in 5 increments of approximately 2 to 3V increments for 115V models or disabled.

Low line limit may be lowered in 5 increments of approximately 4 to 5V increments for 230V models or disabled.

High line limit may be raised in 5 increments of approximately 2 to 3V increments for 115V models or disabled.

High line limit may be raised in 5 increments of approximately 4 to 5V increments for 230V models or disabled.

## Moisture Sensor Alarm

The moisture sensor alarm may be disabled. It is shipped enabled as the factory default setting.

## Modifying the Display

To enter an offset or to configure the alarms, perform the following steps:

Press and hold MENU button (approximately 10 seconds) until the display shows:

PRODUCTION MENU MASTER RESET?
----------------------------------

It is recommended that you do NOT perform a Master Reset because all offsets and configurations that have been entered will be lost. If you must perform a Master Reset, hold SELECT approximately 5 seconds.

This will reset:

- Vacuum units to mBar
- Vacuum set point to 0 mBar
- Temperature units to °C
- Refrigeration total hours to 0
- Vacuum pump total hours to 0
- RS232 transmission rate to 10 seconds
- Temperature offset to 0°C
- Vacuum offset to 0 mBar
- Low line voltage to 0 V offset

High line voltage to 0 V offset  
Moisture sensor to enabled  
Refrigeration to operate in Manual Mode

The display will default to the main freeze dry display information. If you do not want to restore all factory settings, but want to adjust offsets, press MENU briefly and the display will show:

COLLECTOR TEMP OFFSET:  
0 C

Press SELECT until the appropriate offset is shown. Each number represents 1°C

Press MENU and, if the drying chamber has been installed, the display will show:

SDC TEMP. OFFSET:  
0 C

Press SELECT until the appropriate offset is shown. Each number represents 1°C.

Press MENU and the display will show:

VACUUM OFFSET:  
0 uBar

Press SELECT until the appropriate offset is shown. Each number represents 0.001 mBar

Press MENU and the display will show

LOW LINE OFFSET:  
0

Press SELECT until the appropriate offset is shown. If the Freeze Dryer is operating on nominal 115V, each number represents 2V. If 3 is entered into the display, the low line alarm will alarm when the voltage drops to approximately 97V, for example.  $103 - (2 \times 3) = 97V$ . If the Freeze Dryer is operating on nominal 230V each number represents 4V (if 3 is entered into the display, the low line alarm will alarm when the voltage drops to approximately 194V, for example.  $206 - (4 \times 3) = 194V$ .

There will be no alarm indicated if DISABLED is selected.



Press MENU and the display will show

HIGH LINE OFFSET:  
0

Press SELECT until the appropriate offset is shown. If the Freeze Dryer is operating on nominal 115V, each number represents 2V. If 3 is entered into the display, the high line alarm will alarm when the voltage raises to approximately 133V, for example.  $127+(2 \times 3)=133V$ . If the Freeze Dryer is operating on nominal 230V each number represents 4V (if 3 is entered into the display, the low line alarm will alarm when the voltage drops to approximately 266V, for example.  $254+(4 \times 3)=266V$ . There will be no alarm indicated if DISABLED is selected.

Press MENU and the display will show

DRYING CHAMBER:  
NOT INSTALLED

Press and hold SELECT to change the status.

Press MENU and the display will show:

PURGE VALVE:  
NOT INSTALLED

Press and hold SELECT to change the status.

Press MENU and the display will show

DEFROST HEATER:  
NOT INSTALLED

Press and hold SELECT to change the status.

Press MENU and the display will show

MOISTURE SENSOR:  
INSTALLED

Press and hold SELECT if you want to disable the moisture sensor.

Press MENU and the display again show

SHELL FREEZER:  
NOT INSTALLED

Press and hold SELECT to change the status.

Press MENU and the display will show

HOLD SELECT TO CLEAR  
ALL TOTAL HOURS?

If you want to reset Total Hours, press and hold SELECT until an audible beep is heard. The display will default to the main freeze dry display information.

If you do not want to set Total Hours, press MENU and the display will show.

PRODUCTION MENU:  
MASTER RESET?

The routine will repeat by pressing MENU or wait approximately 10 seconds for the display to default to the main freeze dry information display information.

In order to store offsets in memory, you Must Press and Hold MENU until the display shows.

PASSWORD:

Wait approximately 10 seconds and the display will default to the main freeze dry display information. This can be done anytime throughout the Modifying the Display routine.

---

# **APPENDIX A**

# **FREEZE DRYER**

# **COMPONENTS**

The following pages list components that are available for your Freeze Dryer. The parts shown are the most common replacement parts. If other parts are required, contact Product Service.

Item	Model	Part No.	Description
1.	All	7689900	Lid Gasket – Collector
2.	All	7532900	Lid Collector
3.	All	7408400	Lid Gasket - Drying Chamber-Shell Freezer
4.	All	7408300	Lid - Drying Chamber
	6L	7403100	Lid -Shell Freezer
5	6L	7750602	Compressor 115V, 60 Hz.
	6L	7750601	Compressor 230V, 50 Hz.
	6L	7750600	Compressor 230V, 60 Hz.
	6L Cascade	7591800	Compressor 115V, 60 Hz. Hi Stage
	6L Cascade	7591800	Compressor 115V, 60 Hz. Lo Stage
	6L Cascade	7591801	Compressor 230V, 50 Hz. Hi Stage
	6L Cascade	7591801	Compressor 230V, 50 Hz. Lo Stage
	6L Cascade	7591802	Compressor 230V, 60 Hz. Hi Stage
	6L Cascade	7591802	Compressor 230V, 60 Hz. Lo Stage
	12L	7592001	Compressor 230V, 50 Hz.
	12L	7592000	Compressor 230V, 60 Hz
	12L Cascade	7750601	Compressor 230V, 50 Hz. Hi Stage
	12L Cascade	7750601	Compressor 230V, 50 Hz. Lo Stage
	12L Cascade	7750600	Compressor 230V, 60 Hz. Hi Stage
	12L Cascade	7750600	Compressor 230V, 60 Hz. Lo Stage
	18L	7391801	Compressor 230V, 50 Hz.
	18L	7391800	Compressor 239V, 60 Hz
6.	6L	7591800	Compressor 115V, 60 Hz. Shell Freezer
	6L	7591801	Compressor 230V, 50 Hz. Shell Freezer
	6L	7591802	Compressor 230V, 60 Hz. Shell Freezer
7.	6L	7953800	Motor Fan 115V
	All	7953801	Motor Fan 230V
8.	All	1302300	Switch
9.	All	7403500	Label Control Panel
	All	7403501	Label Control Panel with Purge
	All	7403502	Label Control Panel with Purge and Shell Freezer/Drying Chamber
10.	All	7445500	Printed Circuit Board Control
11.	All	7448000	Printed Circuit Board RS232
12.	All	7728000	Drain Plug
13.	All	1643600	O Ring
14.	All	7645904	Drain Hose
15.	All	7646000	Vacuum Hose (Not Shown)
16.	6L	1336400	Power Cord 115V
	All	1342100	Power Cord 230V
17.	All	7445400	Vacuum Sensor
18.	All	7515300	Temperature Sensor – Collector (Not Shown)
19.	6L	7515300	Temperature Sensor – Shell Freezer (Not Shown)

---

---

Appendix A: Freeze Dryer Components

---

---

<b>Item</b>	<b>Model</b>	<b>Part No.</b>	<b>Description</b>
20.	All	7515300	Temperature Sensor – Drying Chamber (Not Shown)
21.	6L, 12L, 18L	7404900	Wire Harness (Not Shown)
	6L, 12L Cascade	7446500	Wire Harness (Not Shown)
22.	All	7514900	Wire Harness Control (Not Shown)
23.	All	7418300	Wire Harness RS232 (Not Shown)
24.	All	7432700	Valve Vacuum Bleed
25.	6L	1363102	Valve Purge 115V
	All	1363103	Valve Purge 230V
26.	All	7814600	Valve Drying Chamber
27.	6L	7407300	Heater Drying Chamber 115V
	All	7407301	Heater Drying Chamber 230V
28.	All	7429700	Moisture Sensor
29.	6L	1289200	Relay Vacuum Pump 115V
	All	1289100	Relay Vacuum Pump 230V
30.	All	1289200	Relay Refrigeration
31.	All	7403800	Filter Vacuum Bleed Valve



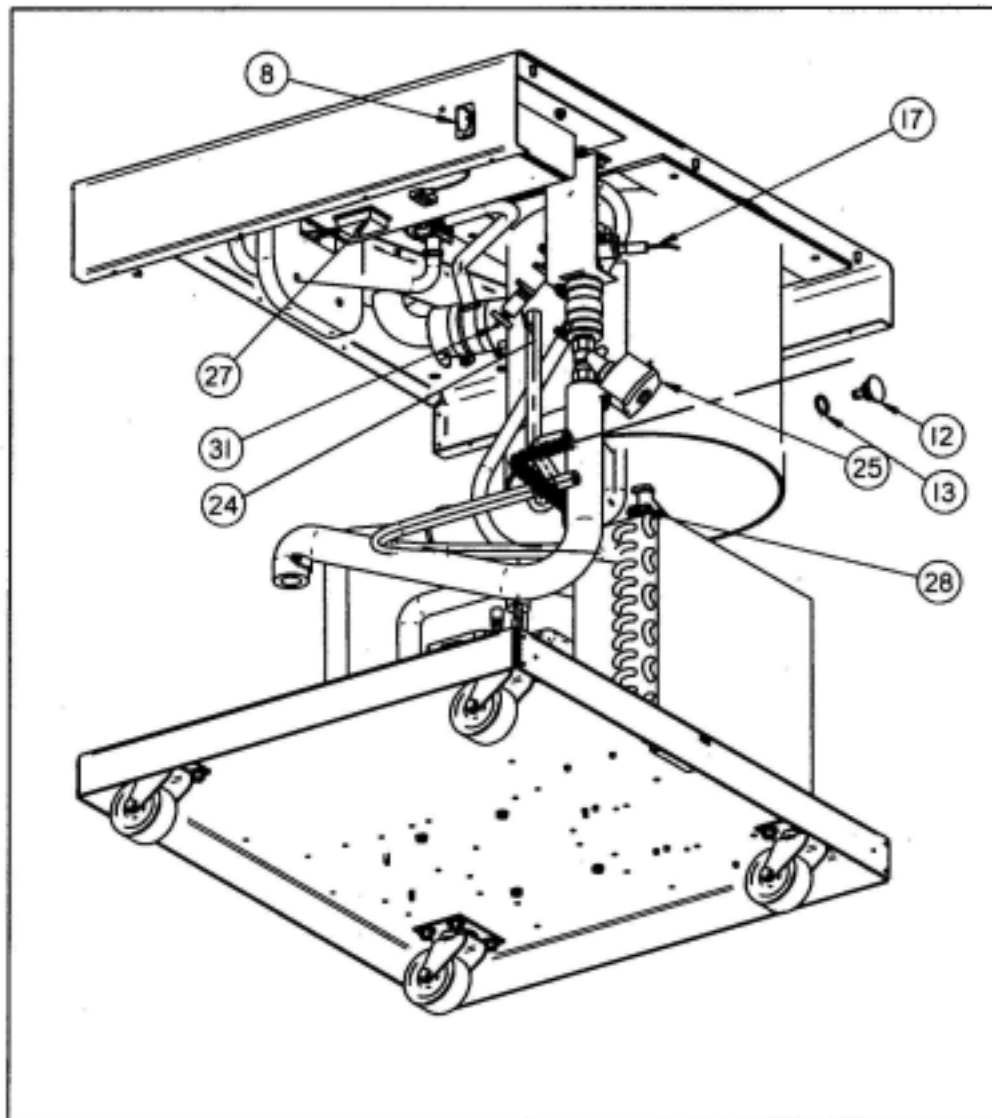

---

# APPENDIX B

# FREEZE DRYER

# DIMENSIONS

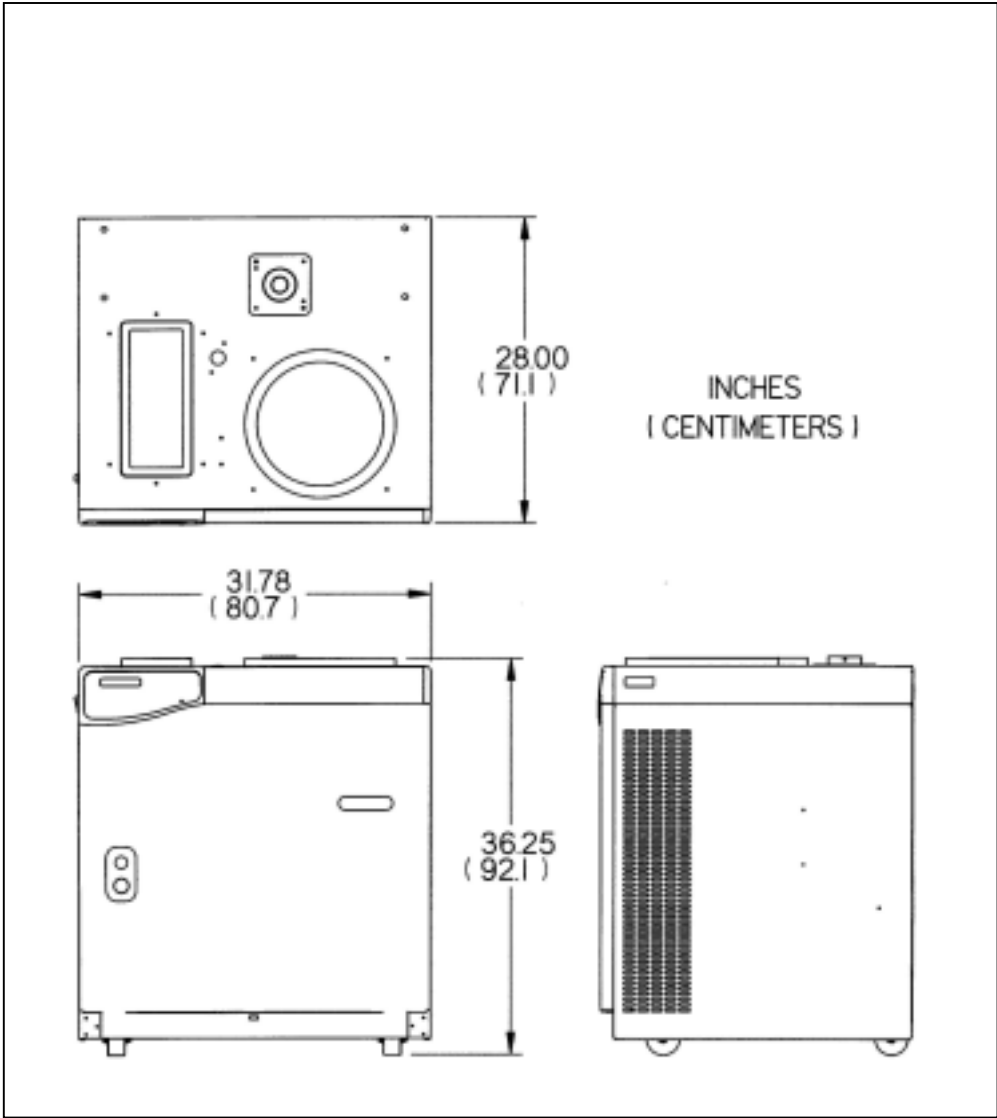



---

# APPENDIX C

## FREEZE DRYER

### SPECIFICATIONS

This Appendix contains technical information about the Freeze Dryer including electrical specifications, environmental operating conditions and wiring diagrams.

#### Electrical Specifications, 6L, 12L, and 18L Console

Catalog Number	Description	Voltage		Frequency	Phase	Amperage	
		Nominal	Operating Range			w/o Vacuum Pump	Max with Vacuum Pump
7753020	6 Liter Freeze Dryer	115	103-127	60	1	9	16
		100	90-110	50	1	9	16
7753021	6 Liter Freeze Dryer	115	103-127	60	1	9	16
		100	90-110	50	1	9	16
7753022	6 Liter Freeze Dryer	115	103-127	60	1	9	16
		100	90-110	50	1	9	16
7753024	6 Liter Freeze Dryer	115	103-127	60	1	9	16
		100	90-110	50	1	9	16
7753026	6 Liter Freeze Dryer	115	103-127	60	1	9	16
		100	90-110	50	1	9	16
7753027	6 Liter Freeze Dryer	115	103-127	60	1	9	16
		100	90-110	50	1	9	16
7753030	6 Liter Freeze Dryer	230	198-254	50	1	3	8
7753031	6 Liter Freeze Dryer	230	198-254	50	1	3	8
7753032	6 Liter Freeze Dryer	230	198-254	50	1	3	8
7753034	6 Liter Freeze Dryer	230	198-254	50	1	3	8
7753036	6 Liter Freeze Dryer	230	198-254	50	1	3	8
7753037	6 Liter Freeze Dryer	230	198-254	50	1	3	8
7753040	6 Liter Freeze Dryer	230	187-253	60	1	3	8
7753041	6 Liter Freeze Dryer	230	187-253	60	1	3	8
7753042	6 Liter Freeze Dryer	230	187-253	60	1	3	8

*Appendix C : Freeze Dryer Specifications*

Catalog Number	Description	Voltage		Frequency	Phase	Amperage	
		Nominal	Operating Range			w/o Vacuum Pump	Max with Vacuum Pump
7753042	6 Liter Freeze Dryer	230	187-253	60	1	3	8
7753044	6 Liter Freeze Dryer	230	187-253	60	1	3	8
7753046	6 Liter Freeze Dryer	230	187-253	60	1	3	8
7753047	6 Liter Freeze Dryer	230	187-253	60	1	3	8
7753522	6 Liter Freeze Dryer	115	103-127	60	1	13	16
		100	90-110	50	1	13	16
7753524	6 Liter Freeze Dryer	115	103-127	60	1	13	16
		100	90-110	50	1	13	16
7753532	6 Liter Freeze Dryer	230	198-254	50	1	5.5	10
7753534	6 Liter Freeze Dryer	230	198-254	50	1	5.5	10
7753542	6 Liter Freeze Dryer	230	187-253	60	1	5.5	10
7753544	6 Liter Freeze Dryer	230	187-253	60	1	5.5	10
7934020	6 Liter Cascade Freeze Dryer	115	103-127	60	1	11	16
		100	90-110	50	1	11	16
7934021	6 Liter Cascade Freeze Dryer	115	103-127	60	1	11	16
		100	90-110	50	1	11	16
7934022	6 Liter Cascade Freeze Dryer	115	103-127	60	1	11	16
		100	90-110	50	1	11	16
7934024	6 Liter Cascade Freeze Dryer	115	103-127	60	1	11	16
		100	90-110	50	1	11	16
7934026	6 Liter Cascade Freeze Dryer	115	103-127	60	1	11	16
		100	90-110	50	1	11	16
7934027	6 Liter Cascade Freeze Dryer	115	103-127	60	1	11	16
		100	90-110	50	1	11	16
7934030	6 Liter Cascade Freeze Dryer	230	198-254	50	1	5.5	10
7934031	6 Liter Cascade Freeze Dryer	230	198-254	50	1	5.5	10
7934032	6 Liter Cascade Freeze Dryer	230	198-254	50	1	5.5	10
7934034	6 Liter Cascade Freeze Dryer	230	198-254	50	1	5.5	10
7934036	6 Liter Cascade Freeze Dryer	230	198-254	50	1	5.5	10
7934037	6 Liter Cascade Freeze Dryer	230	198-254	50	1	5.5	10
7934040	6 Liter Cascade Freeze Dryer	230	187-253	60	1	5.5	10
7934041	6 Liter Cascade Freeze Dryer	230	187-253	60	1	5.5	10
7934042	6 Liter Cascade Freeze Dryer	230	187-253	60	1	5.5	10
7934044	6 Liter Cascade Freeze Dryer	230	187-253	60	1	5.5	10
7934046	6 Liter Cascade Freeze Dryer	230	187-253	60	1	5.5	10
7934047	6 Liter Cascade Freeze Dryer	230	187-253	60	1	5.5	10

---



---

*Appendix C: Freeze Dryer Specifications*

---



---

Catalog Number	Description	Voltage				Amperage	
		Nominal	Operating Range	Frequency	Phase	w/o Vacuum Pump	Max with Vacuum Pump
7754030	12 Liter Freeze Dryer	230	198-254	50	1	4.5	9
7754031	12 Liter Freeze Dryer	230	198-254	50	1	4.5	9
7754032	12 Liter Freeze Dryer	230	198-254	50	1	4.5	9
7754034	12 Liter Freeze Dryer	230	198-254	50	1	4.5	9
7754036	12 Liter Freeze Dryer	230	198-254	50	1	4.5	9
7754037	12 Liter Freeze Dryer	230	198-254	50	1	4.5	9
7754040	12 Liter Freeze Dryer	230	187-253	60	1	5	9
7754041	12 Liter Freeze Dryer	230	187-253	60	1	5	9
7754042	12 Liter Freeze Dryer	230	187-253	60	1	5	9
7754044	12 Liter Freeze Dryer	230	187-253	60	1	5	9
7754046	12 Liter Freeze Dryer	230	187-253	60	1	5	9
7754047	12 Liter Freeze Dryer	230	187-253	60	1	5	9
7960030	12 Liter Cascade Freeze Dryer	230	198-254	50	1	5.5	10
7960031	12 Liter Cascade Freeze Dryer	230	198-254	50	1	5.5	10
7960032	12 Liter Cascade Freeze Dryer	230	198-254	50	1	5.5	10
7960034	12 Liter Cascade Freeze Dryer	230	198-254	50	1	5.5	10
7960036	12 Liter Cascade Freeze Dryer	230	198-254	50	1	5.5	10
7960037	12 Liter Cascade Freeze Dryer	230	198-254	50	1	5.5	10
7960040	12 Liter Cascade Freeze Dryer	230	187-253	60	1	6.5	11
7960041	12 Liter Cascade Freeze Dryer	230	187-253	60	1	6.5	11
7960042	12 Liter Cascade Freeze Dryer	230	187-253	60	1	6.5	11
7960044	12 Liter Cascade Freeze Dryer	230	187-253	60	1	6.5	11
7960046	12 Liter Cascade Freeze Dryer	230	187-253	60	1	6.5	11
7960047	12 Liter Cascade Freeze Dryer	230	187-253	60	1	6.5	11
7755030	18 Liter Freeze Dryer	230	198-254	50	1	5.5	10
7755031	18 Liter Freeze Dryer	230	198-254	50	1	5.5	10
7755032	18 Liter Freeze Dryer	230	198-254	50	1	5.5	10
7755034	18 Liter Freeze Dryer	230	198-254	50	1	5.5	10
7755036	18 Liter Freeze Dryer	230	198-254	50	1	5.5	10
7755037	18 Liter Freeze Dryer	230	198-254	50	1	5.5	10
7755040	18 Liter Freeze Dryer	230	187-253	60	1	5.5	10
7755041	18 Liter Freeze Dryer	230	187-253	60	1	5.5	10
7755042	18 Liter Freeze Dryer	230	187-253	60	1	5.5	10
7755044	18 Liter Freeze Dryer	230	187-253	60	1	5.5	10
7755046	18 Liter Freeze Dryer	230	187-253	60	1	5.5	10
7755047	18 Liter Freeze Dryer	230	187-253	60	1	5.5	10

## Environmental Conditions

- Indoor use only.
- Maximum altitude: 6562 feet (2000 meters).
- Ambient temperature range: 41° to 104°F (5° to 40°C).
- Maximum relative humidity: 80% for temperatures up to 88°F (31°C), decreasing linearly to 50% relative humidity at 104°F (40°C).
- Main supply voltage fluctuations not to exceed  $\pm 10\%$  of the nominal voltage.
- Transient over voltages according to Installation Categories II (Over voltage Categories per IEC 1010). Temporary voltage spikes on the AC input line that may be as high as 1500V for 115V models and 2500V for 230V models are allowed.
- Used in an environment of Pollution degrees 2 (i.e., where normally only non-conductive atmospheres are present). Occasionally, however, a temporary conductivity caused by condensation must be expected, in accordance with IEC 664.

### Wiring Diagram Catalog #77530xx and 77535xx, 79340xx (115V, 60 Hz Models)

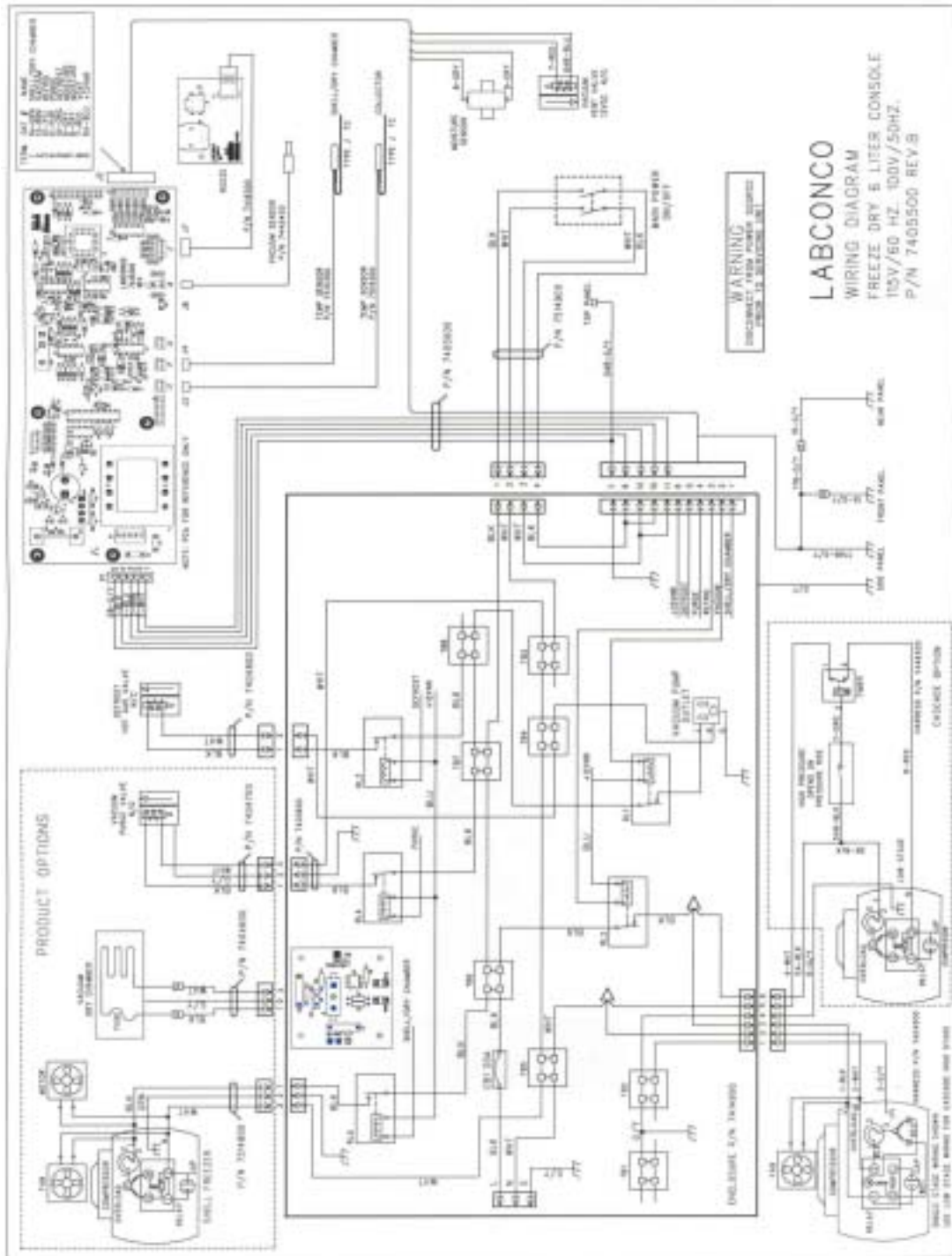

**Wiring Diagram Catalog #79340xx, (230V, 50 or 60 Hz Models)**

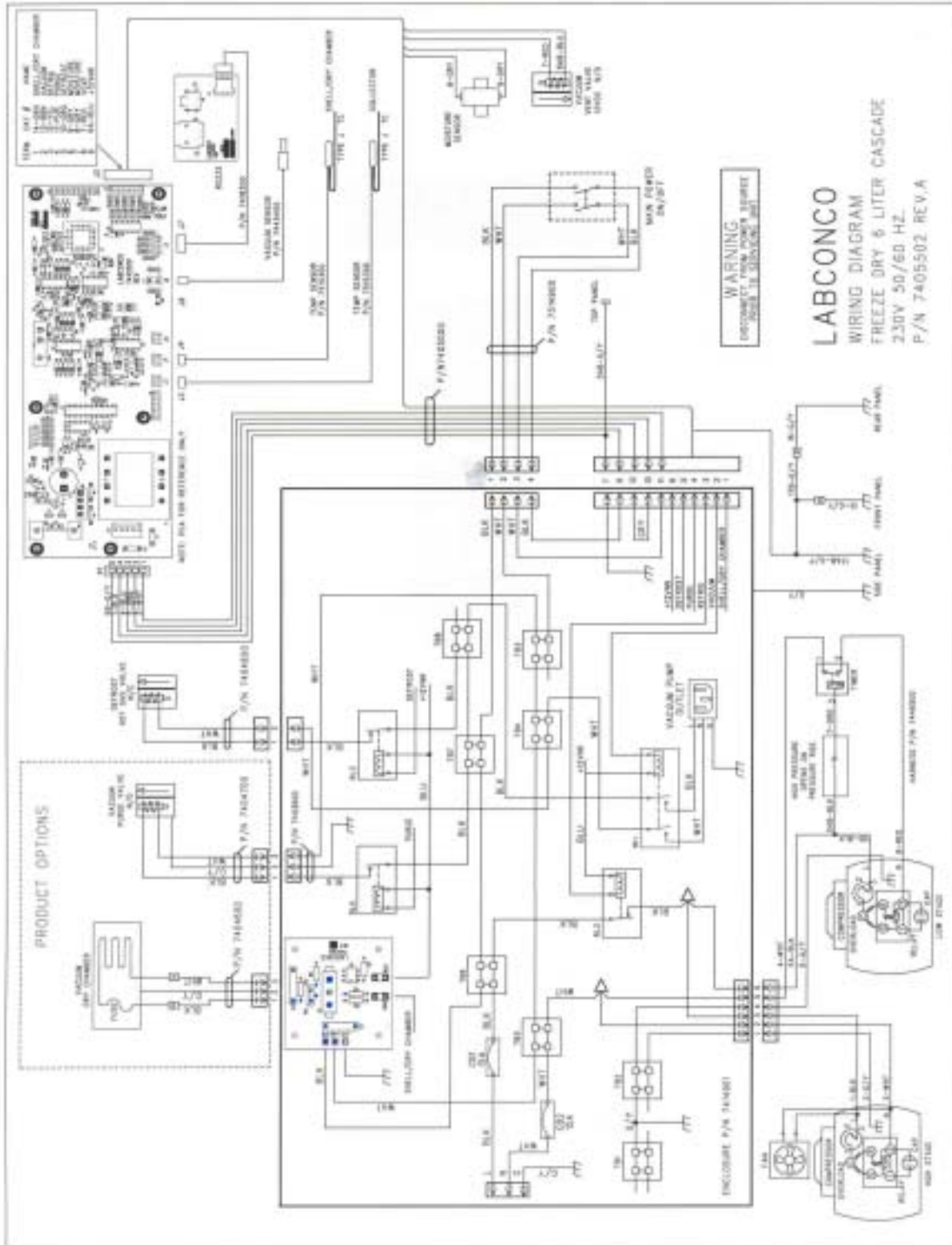



---

# APPENDIX D

## FREEZE DRYER

### ACCESSORIES

The following accessories are available for the Freeze Dryer.

<b>PART #</b>	<b>DESCRIPTION</b>
1467700	<b>Vacuum Pump</b> Two stage direct drive pump, 195 liters/minute. 115 VAC, 50/60 Hz, single phase, 7.8 amps. Includes Pump Exhaust Filter 1473400. (Catalog #1473400)
7739403	<b>Vacuum Pump</b> Two stage direct drive pump, 195 liters/minute. 230 VAC, 50/60 Hz, single phase, 4.0 amps. Includes Pump Exhaust Filter 1473400. (Catalog #1473400)
7439000	<b>Vacuum Pump</b> Two stage direct drive pump, 173 liters/minute. 115 VAC, 50/60 Hz, single phase 5.8 amps. Includes Pump Exhaust Filter. (Catalog #7670400)
7439200	<b>Vacuum Pump</b> Two stage direct drive pump, 173 liters/minute. 230 VAC, 50/60 Hz, single phase 2.9 amps. Includes Pump Exhaust Filter. (Catalog #7670400)
7769600	<b>Vacuum Pump, Chemical Resistant</b> Two stage direct drive pump, 173 liters/minute. 115 VAC, 50/60 Hz, single phase 5.8 amps. Includes Pump Exhaust Filter. (Catalog #7670400)
7769800	<b>Vacuum Pump, Chemical Resistant</b> Two stage direct drive pump, 173 liters/minute. 230 VAC, 50/60 Hz, single phase 2.9 amps. Includes Pump Exhaust Filter.(Catalog #7670400)



<b>PART #</b>	<b>DESCRIPTION</b>
1472200	<b>Pump Inlet Filter</b> Disposable filter that prevents oil back streaming and protects vacuum pump from sub micron particles. Fits vacuum pumps 1466700 and 7739403.
1473400	<b>Pump Exhaust Filter</b> Disposable filter that removes visible oil mist and odor from vacuum pump exhaust. Fits vacuum pumps 1467700 and 7739403.
1473200	<b>Replacement Element, Oil Mist, Pump Exhaust Filter</b> Fits pump exhaust filter 1473400.
1473300	<b>Replacement Element, Odor, Pump Exhaust Filter, package of 5</b> Fits pump exhaust filter 1473400 or vacuum pumps 1467700 and 7739403.
7670400	<b>Replacement Filter – Element</b> Disposable filter that removes oil mist from the vacuum pump exhaust. Fits vacuum pumps 7439000, 7439200, 7769600 and 7769800
1988000	<b>Vacuum Pump Oil, 1 Liter</b> A molecularly distilled hydrocarbon oil with low vapor pressure. For vacuum pumps 1467700 and 7739403
7772000	<b>Soda Acid Trap</b> Secondary trap that prevents migration of corrosive chemicals into vacuum pump.
7772100	<b>Replacement Media for Soda Acid Trap</b>
7772700	<b>Vacuum Pump Oil 1 Liter</b> A mineral oil with low vapor pressure. For vacuum pumps 7439000, 7439200, 7769600, 7769800
7772500	<b>Carbon Solvent Trap</b> Secondary trap that prevents migration of organic solvents into vacuum pump.
7772600	<b>Replacement Activated Carbon Media for Carbon Solvent Trap</b>

<b>PART #</b>	<b>DESCRIPTION</b>
7538000	<b>Secondary Vacuum Cold Trap</b> Provides additional protection for the vacuum pump when processing low eutectic samples. 9 ¾" high x 7 7/8" diameter, 304 stainless steel with ¾" vacuum connections. For use with dry ice and solvent. Cools to approximately -75°C.
7522800	<b>12 Port Drying Chamber</b> 9 ¾" high x 7 7/8" diameter, 304 stainless steel with 12 freeze dry valves.
7522900	<b>16 Port Drying Chamber</b> 13" high x 138" diameter, 304 stainless steel with 16 freeze dry valves.
7443500	<b>Clear Drying Chamber with 8 Valves</b> For bulk drying or drying in flasks. 9.0 Dia.
7444000	<b>Clear Drying Chamber with 8 Valves</b> For bulk drying or drying in flasks. 12.0 Dia.
7442900	<b>Clearing Drying Chamber</b> For bulk drying. 9.0 Dia.
7867000	<b>Clear Drying Chamber</b> For Bulk Drying 12.0 Dia.
7521000	<b>Heated Drying Chamber</b> 10 ½" high x 9" diameter type 304 stainless steel. The 3 shelf product heaters heat to 43°C (110°F). 115V.
7521001	<b>Heated Drying Chamber</b> 10 ½" high x 9" diameter type 304 stainless steel. The 3 shelf product heaters heat to 43°C (110°F). 230V.
7509200	<b>Product Heater</b> For use in chamber 7522800. Provides 3 heated shelves operating at 43°C (110°F). 115V
7509201	<b>Product Heater</b> For use in chamber 7522800. Provides 3 heated shelves operating at 43°C (110°F). 230V
7442100	<b>Drying Rack- Unheated</b> Provides three shelves. For use in chambers 7443500 and 7522800.
7441700	<b>Drying Rack – Unheated</b> Provides three shelves for use in chambers 7444000, 7867000, 7522900
7522300	<b>20 Port Manifold</b> 10" high x 27 ½" wide x 8 5/8" deep. Type 304 stainless steel manifold with 20 freeze dry valves.

<b>PART #</b>	<b>DESCRIPTION</b>
7522400	<b>10 Port Manifold with support shelf</b> 10" high x 26" wide x 6-5/8" deep. Type 304 Stainless Steel Manifold with 10 Freeze Dry Valves & 1 Shelf
7522500	<b>20 Port Manifold with support shelves</b> 10" high x 26" wide x 9-1/2" deep. Type 304 Stainless Steel Manifold with 20 Freeze Dry valves and 2 shelves.
7868500	<b>48 Port Ampule Manifold</b> 28 5/8" high x 5" wide x 5" deep. Type 304 stainless steel with 48 each 1/4" tube stems.
7509600	<b>Sample Valve Kit</b> Includes neoprene valve body, knob and installation parts.
7439902	<b>Glass Collector Chamber Lid</b> For use with solvents that attack the acrylic lid.
7439902	<b>Glass Collector Chamber Lid</b> For use with solvents that attack the acrylic lid.
7509300	<b>Product Heater</b> For use in chamber 7522900, 7444000 and 7867000. Provides 3 heated shelves operating at 43°C (110°F). 115V
7509301	<b>Product Heater</b> For use in chamber 7522900, 7444000 and 7867000. Provides 3 heated shelves operating at 43°C (110°F). 230V
7509400	<b>Product Heater with Variable Heat</b> For use in chamber 7522900, 7444000 and 7867000. Provides variable heat up to 43°C (110°F). 115V
7509401	<b>Product Heater with Variable Heat</b> For use in chamber 7522900, 7444000 and 7867000
7806020	<b>Bulk Tray Dryer</b> 115V, 60 Hz, three shelves, 630 square inches of area, provides heat control
7806021	<b>Bulk Tray Dryer</b> 115V, 60 Hz, three shelves, 630 square inches of area, provides heat control with 6 port manifold
7806022	<b>Bulk Tray Dryer</b> 115V, 60 Hz, three shelves, 630 square inches of area, provides heat control with RS232 output connection.

<b>PART #</b>	<b>DESCRIPTION</b>
7806023	<b>Bulk Tray Dryer</b> 115V, 60 Hz, three shelves, 630 square inches of area, provides heat control with 6 port manifold and RS232 output connection.
7806030	<b>Bulk Tray Dryer</b> 230V, 50/60 Hz, Three shelves, 630 square inches of area, provides heat control.
7806031	<b>Bulk Tray Dryer</b> 230V, 50/60 Hz, Three shelves, 630 square inches of area, provides heat control. With 6 port manifold.
7806032	<b>Bulk Tray Dryer</b> 230V, 50/60 Hz, Three shelves, 630 square inches of area, provides heat control. With RS232 output connection.
7806033	<b>Bulk Tray Dryer</b> 230V, 50/60 Hz, Three shelves, 630 square inches of area, provides heat control. With 6 port manifold and RS232 output connection.
7948020	<b>Stoppering Tray Dryer</b> 115V, 60 Hz, three shelves, 600 square inches of area, provides temperature control and stoppering under vacuum.
7948030	<b>Stoppering Tray Dryer</b> 230V, 50 Hz, three shelves, 600 square inches of area, provides temperature control and stoppering under vacuum.
7948040	<b>Stoppering Tray Dryer</b> 230V, 60 Hz, three shelves, 600 square inches of area, provides temperature control and stoppering under vacuum.
7726500	<b>6 Port Manifold for use with Stoppering Tray Dryer</b> Mounts between the Stoppering Tray Dryer and the base unit and provides 6 freeze dry valves.
7537800	<b>Cable</b> Connect the RS232 output from the Freeze Dryer (or Freeze Dryer/Tray Dryer combination) to an IBM compatible computer with a 9-pin serial data port.
7537801	<b>Cable</b> Connects the RS232 output from the Freeze Dryer (or Freeze Dryer/Tray Dryer combination) to an IBM compatible computer with a 25-pin serial data port.
7761500	<b>Isolation Valve</b> Mounts between the Stoppering Tray Dryer and the base unit which provides a way to isolate the base unit vacuum system from the Stoppering Tray Dryer vacuum system.
7390702	<b>6L Baffle</b> Mounts in the collector chamber to increase ice holding capacity when operating with vacuum control.
7390701	<b>12L Baffle</b> Mounts in the collector chamber to increase ice holding capacity when operating with vacuum control.

## Fast-Freeze® Flasks



Fast-Freeze Flasks are specially designed to be easier to handle, faster to load and more convenient to use than other freeze dry glassware now in your laboratory. Compatible with all major brands of laboratory freeze dry equipment, Fast-Freeze Flasks eliminate the risk of contamination from vacuum grease, reduce spillage of valuable samples and require no washers, gaskets or retainers.

### How to select Fast-Freeze Flasks for your Freeze Dry System

Select Fast-Freeze Flasks based on your sample sizes. Flasks should be filled no more than one-third of their volume so that maximum surface area is achieved and efficient lyophilization is assured. A complete Fast-Freeze Flask includes a rubber top, glass bottom and a supply of filter paper. Tops, bottoms and filter paper are available separately as replacement components. Adapters are required to attach flasks to freeze dry valve ports.

Flask Size	Complete Flask	Flask Bottom	Flask Top	Flask Top Adapter Diameter*	Dimensions/Flask Bottom H x D
40 ml	7540000	7542000	7544000	1/2"	76 mm x 34 mm
80 ml	7540200	7542200	7544000	1/2"	115 mm x 34 mm
120 ml	7540300	7542300	75442-00	3/4"	68 mm x 59.2 mm
150 ml	7540400	7542400	7544200	3/4"	85 mm x 59.2 mm
300 ml	7540600	7542600	7544200	3/4"	145 mm x 59.2 mm
600 ml	7540800	7542800	7544400	3/4"	135 mm x 90.2 mm
900 ml	7540900	7542900	7544400	3/4"	190 mm x 90.2 mm
1200 ml	7541000	7543000	7544400	3/4"	240 mm x 90.2 mm
2000 ml	7541200	7543200	7544400	3/4"	380 mm x 90.2 mm

\*Valves on the freeze dry systems, drying chambers and manifolds offered in this catalog fit adapters of both 1/2" and 3/4" sizes. Size information is provided for selecting adapters for older Labconco models and other freeze dryers.

**Variety of adapters available.** You may select from glass or stainless steel adapters, available straight or with 45° bend. (Required — order separately.)

**Top seals easily.** The flexible silicone rubber top snaps on and off easily, yet provides a reliable, high vacuum seal.

**Compatible with all major brands of laboratory freeze dry apparatus.**

**No complex filter retainer is necessary.** For those who use filters, they are easily inserted between the adapter and top of the flask. One hundred filters are supplied with each flask.

**Only two pieces per flask.** The complete Fast-Freeze Flask has only two components:

- a high strength borosilicate glass bottom to withstand extreme temperatures and high vacuum.
- a flexible, non-contaminating silicone rubber top.

**No vacuum grease is necessary.**

**No threads, hooks or springs are needed.**

**Entire flask may be autoclaved.**

**Wide mouth opening loads fast, cleans easily.**

**Horizontal shell freezing.** Flask may be placed in a horizontal position and rotated in a bath for shell freezing.

**Available in nine convenient sizes.**

**Flat bottom** reduces spills, provides better balance.

### Adapters

Add the Adapters for connecting the Fast-Freeze Flasks to the valve ports on your drying chamber or manifold. Choose borosilicate glass or stainless steel adapters in 1/2" and 3/4" diameters.

Diameter	Straight Adapter	45° Bend Adapter
<b>Borosilicate Glass</b>		
1/2" flask top to 1/2" valve*	7545000	7545600
3/4" flask top to 3/4" valve*	7545200	7545800
1/2" flask top to 3/4" valve*	7545400	7546000
3/4" flask top to 1/2" valve*	7545400	7546000
<b>Stainless Steel</b>		
1/2" flask top to 1/2" valve*	7547000	7547400
3/4" flask top to 3/4" valve*	7547200	7547600

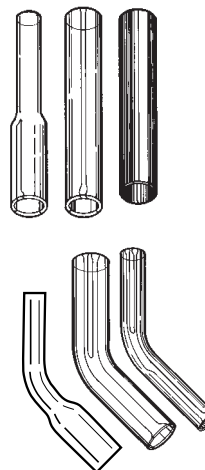

### 7544810 Replacement Filter Paper

1000 (10 packages of 100). 1" diameter (28mm). Pore size 17 microns. Shipping weight 0.5 lb.

# Lyph-Lock® Flasks



Lyph-Lock Flasks simplify your lyophilization procedures because they have only three pieces per flask — a high strength borosilicate glass top and bottom with a silicone rubber ring seal. The unique wide-mouth design helps you load samples easily and lyophilize efficiently.

## How to select Lyph-Lock Flasks for your Freeze Dry System

Select the Lyph-Lock Flasks based on your sample sizes. Flasks should be filled to no more than one-third of their volume so that maximum surface area is achieved and efficient lyophilization is ensured. A complete Lyph-Lock Flask includes a glass top and bottom and a rubber ring seal. Tops, bottoms and seals are available separately as replacement components. Adapters are required to attach flasks to freeze dry valve ports.

Flask Size	Complete Flask 19/38 STJ	Complete Flask 24/40 STJ	Flask Top 19/38 STJ	Flask Top 20/40 STJ	Lyph-Lock Seal	Flask Bottom	Dimensions Flask Bottom H x ID
25 ml	7550000	7554000	7552000	7556000	75590-00	75570-00	37 mm x 34 mm
50 ml	7550200	7554200	7552000	7556000	7559000	7557200	67 mm x 34 mm
100 ml	7550400	7554400	7552200	7556200	7559200	7557400	50 mm x 59.2 mm
250 ml	7550600	7554600	7552200	7556200	7559200	7557600	110 mm x 59.2 mm
500 ml	7550800	7554800	7552400	7556400	7559400	7557800	103 mm x 90.2 mm
750 ml	7550900	7554900	7552400	7556400	7559400	7557900	145 mm x 90.2 mm
1000 ml	7551000	7555000	7552400	7556400	7559400	7558000	187 mm x 90.2 mm

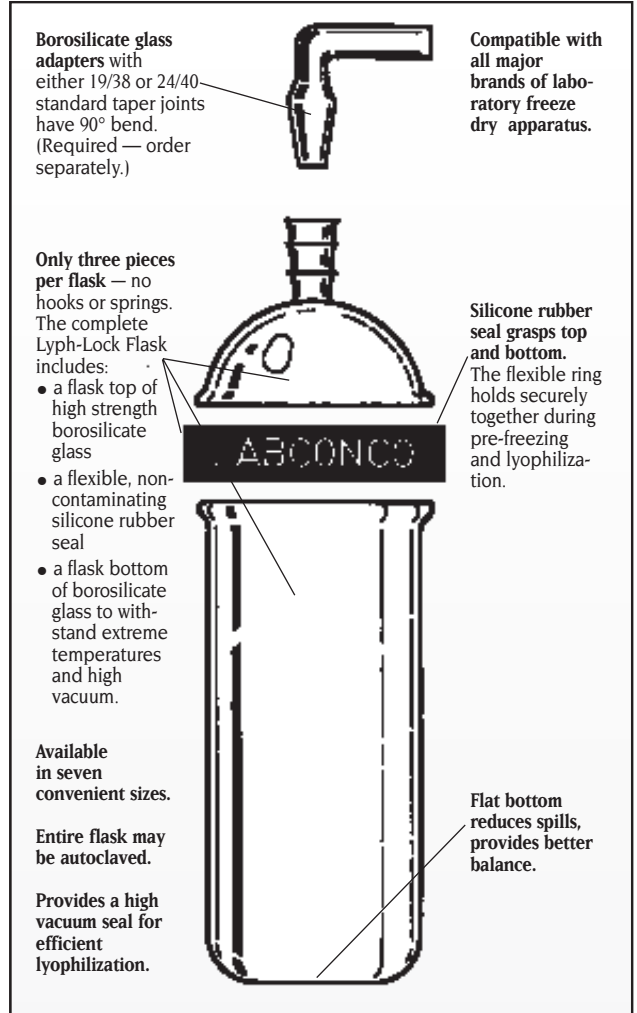

## Adapters

Add the Adapters for connecting the Lyph-Lock Flasks to the valve ports on your drying chamber or manifold.

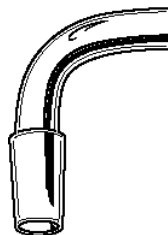

90° Bend Adapter	Description
7568000	Connects 19/38 STJ Flask Top to 1/2" valve*
7568200	Connects 19/38 STJ Flask Top to 3/4" valve*
7568400	Connects 24/40 STJ Flask Top to 1/2" valve*
7568600	Connects 24/40 STJ Flask Top to 3/4" valve*

\*Valves on the freeze dry systems, drying chambers and manifolds offered in this catalog fit adapters of both 1/2" and 3/4" sizes. Size information is provided for selecting adapters for older Labconco models and other freeze dryers.

## Serum Bottles and Vials



Perfect for long term storage of freeze dried samples. Labconco Serum Bottles and Threaded Vials are specifically designed for lyophilization applications. Their uniform thin wall construction ensures even freezing and drying. Bottles and vials are ideal containers for use in the FreeZone Stoppering Tray Dryer. Serum bottles also connect to valve ports on drying chambers and manifolds.

### Serum Bottles

Serum Bottles, Stoppers and Seals are supplied in packages of 100.

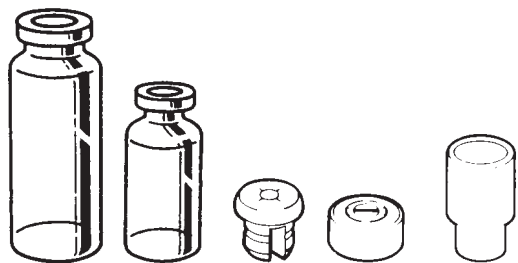

Size	20 mm Corkage	13 mm Corkage	Split Stoppers	Aluminum Seals	Sleeve-Type Stoppers
2 ml		7575010	7576010	7577010	
3 ml		7575210	7576010	7577010	
5 ml	7573010		7576210	7577110	7577510
10 ml	7573210		7576210	7577110	7577510
20 ml	7573410		7576210	7577110	7577510
30 ml	7573610		7576210	7577110	7577510
50 ml	7573810		7576210	7577110	7577510
100 ml	7574010		7576210	7577110	7577510
125 ml	7574210		7576210	7577110	7577510

### Threaded Vials

Stoppers and Threaded Vials with Screw Caps are supplied in packages of 200.

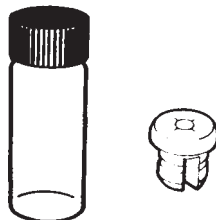

Size	Vials with Screw Caps	Stoppers
5 ml	7762300	7762200
10 ml	7762600	7762200

### Accessories



### Seal Crimper

Secures tear-away Aluminum Seals.

**7578000 Seal Crimper** for 13 mm corkage.

Shipping weight 3 lbs. (1.4 kg).

**7578100 Seal Crimper** for 20 mm corkage.

Shipping weight 3 lbs. (1.4 kg).

### Vacuum Stoppering Adapter

**7593000 Adapter** connects to valve ports for manual stoppering of 20 mm corkage serum bottles under original vacuum. The stopper and serum bottle are inserted into the adapter body and lyophilization begins. After the process is completed, the researcher slides the stopper into position so when the valve is turned from vacuum to vent the serum bottle is tightly sealed by the stopper. The ejector tube is then used to force the serum bottle out of the adapter.

Shipping weight 1 lb. (0.4 kg).

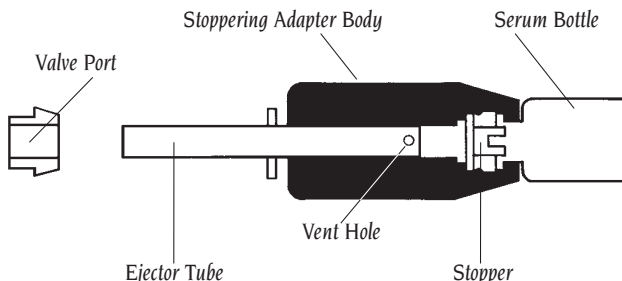



## Ampules

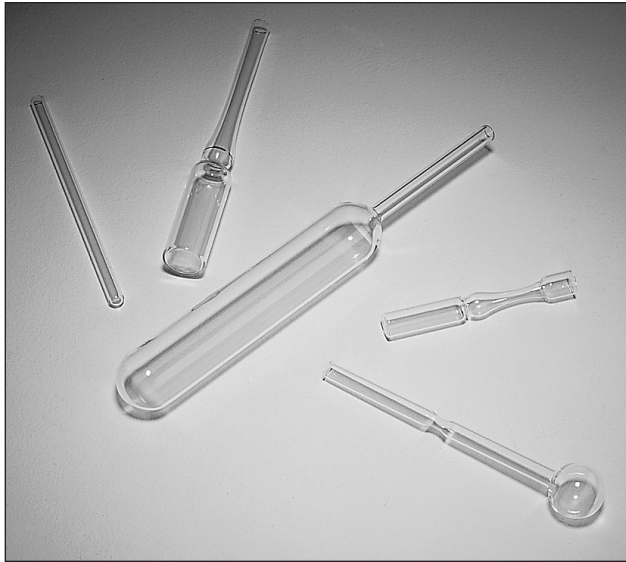

Labconco Ampules are fabricated of highest quality borosilicate glass for strength and durability. They are available in five different configurations to provide the ideal ampule for your specific lyophilization requirements, from tray drying to flame sealing applications.

### Ampules

Ampules are supplied in packages of 100.



Size	Straight	Bulb-Type	Pre-Scored Flat Bottom	Round Bottom	Stoppering
1 ml	7572710	7570010	7570610		
2 ml			7570810		7572310
4 ml	7572810				
5 ml		7570210	7571010		
10 ml			7571210	7571610	
25 ml				7571810	
50 ml				7572010	

## Accessories



### Oxygen/Natural Gas Sealing Torch

**7578500 Torch** specifically designed for flame sealing freeze dry ampules. Seals all types of heat-resistant glass. Connects to natural gas, butane or propane and oxygen with 1/4" ID hose connectors. Shipping weight 3 lbs. (1.4 kg).



### Ampule Valve Adapters

**7593401 Adapter** connects ampules to valve ports or stainless steel stems. Ten per package. Shipping weight 0.5 lb. (0.2 kg).



### Stoppers

**7572510 Stopper** for Stoppering Ampules 75723-10. 100 per package. Shipping weight 3 lbs. (1.4 kg).



### Trident Adapter

**7762700 Three Way Adapter** permits attachment of three ampules to a single valve port. Ampules are attached using Ampule Valve Adapters or 1/8" surgical tubing (not provided). Cavity in adapter body can be filled with cotton fiber media to help prevent contamination between samples. Shipping weight 3 oz. (0.1 kg).



### DECLARATION OF CONFORMITY

Application Council Directive(s): 73/23/EEC, 89/336/EEC

Standard(s) to which conformity is declared: EN61010, EN55022, EN50082-1

Manufacturer's Name: Labconco Corporation

Manufacturer's Address: 8811 Prospect Avenue  
Kansas City, MO 64132 USA

Importer's Name: See Shipping/Customs Documents\*

Importer's Address: See Shipping/Customs Documents for your equipment

Type of Equipment: Laboratory Equipment – Freeze Dryer

Model No.: 775 followed by two digit number based on model size; followed by another two digit number based on options.  
77400 followed by two digit number based on options.  
79340 followed by two digit number based on options.  
767 followed by two digit number based on model size; followed by another two digit number based on options.  
79600 followed by two digit number based on options.  
74200 followed by two digit number based on options.

Serial No.: Various – See Individual Declaration

Year of Manufacture: 1995 and Subsequent

I, the undersigned, hereby declare that the equipment specified above conforms to the above Directive(s) and Standard(s).

See individual Declaration of Conformity which will be signed by the importer for your country.

Place: \_\_\_\_\_  
(Signature)

Date: \_\_\_\_\_  
(Full Name)

\_\_\_\_\_  
(Position)

\*An individual version of this declaration is included with your shipping/customs documentation.

Labconco P/N 36960-02, Rev. E, ECO C010

For more information, please contact us:

[ExpotechUSA](#)  
[10700 Rockley Road](#)  
[Houston, Texas 77099](#)  
[USA](#)

[281-496-0900 \[voice\]](#)

[281-496-0400 \[fax\]](#)

E-mail: [sales@expotechusa.com](mailto:sales@expotechusa.com)

Website: [www.ExpotechUSA.com](http://www.ExpotechUSA.com)